

Miniature Aluminum Electrolytic Capacitors

NRWA Series

RADIAL LEADS, POLARIZED, STANDARD SIZE, EXTENDED TEMPERATURE

FEATURES

- REDUCED CASE SIZING
- -55°C ~ +105°C OPERATING TEMPERATURE
- HIGH STABILITY OVER LONG LIFE

EXTENDED TEMPERATURE
NRWA → **NRWS**
 (today's standard) (reduced sizes)

RoHS Compliant
 includes all homogeneous materials

*See Part Number System for Details

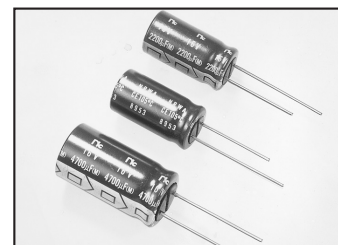

CHARACTERISTICS

Rated Voltage Range		6.3 ~ 100VDC							
Capacitance Range		0.47 ~ 10,000μF							
Operating Temperature Range		-55°C ~ +105°C							
Capacitance Tolerance		±20% (M)							
Maximum Leakage Current @ +20°C	After 1 min.	0.03CV or 4μA whichever is greater							
	After 2 min.	0.01CV or 3μA whichever is greater							
Max. Tan δ at 120Hz/20°C	W.V. (Vdc)	6.3	10	16	25	35	50	63	100
	S.V. (Vdc)	8	13	20	32	44	63	79	125
	C ≤ 1,000μF	0.22	0.19	0.16	0.14	0.12	0.10	0.09	0.08
	C = 2,200μF	0.24	0.21	0.18	0.16	0.14	0.12	-	-
	C = 3,300μF	0.26	0.23	0.20	0.18	0.16	-	-	-
	C = 4,700μF	0.28	0.25	0.22	0.20	-	-	-	-
	C = 6,800μF	0.32	0.29	0.26	-	-	-	-	-
Low Temperature Stability Impedance Ratio @ 120Hz	Z-25°C/Z+20°C	4	3	2	2	2	2	2	2
	Z-40°C/Z+20°C	8	6	4	3	3	3	3	3
Load Life Test at Rated W.V +105°C 1,000 Hours: 5~12.5φ 2,000 Hours: 16φ	Δ Capacitance	Within ±20% of initial measured value							
	Δ Tan δ	Less than 200% of specified value							
	Δ LC	Less than specified value							
Shelf Life Test +105°C 1,000 Hours No Load	Δ Capacitance	Within ±20% of initial measured value							
	Δ Tan δ	Less than 200% of specified value							
	Δ LC	Less than specified value							

STANDARD PRODUCT AND CASE SIZE TABLE Dφ x L (mm)

Cap. (μF)	Code	Working Voltage (Vdc)							
		6.3	10	16	25	35	50	63	100
0.47	R47	-	-	-	-	-	5x11	-	5x11
1.0	1R0	-	-	-	-	-	5x11	-	5x11
2.2	2R2	-	-	-	-	-	5x11	-	5x11
3.3	3R3	-	-	-	-	-	5x11	5x11	5x11
4.7	4R7	-	-	-	5x11	5x11	5x11	5x11	5x11
10	100	-	-	5x11	5x11	5x11	5x11	5x11	6.3x11
22	220	-	5x11	5x11	5x11	5x11	5x11	6.3x11	8x11.5
33	330	5x11	5x11	5x11	5x11	5x11	6.3x11	6.3x11	10x12.5
47	470	5x11	5x11	5x11	5x11	6.3x11	6.3x11	8x11.5	10x16
100	101	5x11	5x11	6.3x11	6.3x11	8x11.5	8x11.5	10x12.5	12.5x20
220	221	-	6.3x11	8x11.5	8x11.5	10x12.5	10x16	10x20	16x25
330	331	6.3x11	-	8x11.5	10x12.5	10x16	10x20	12.5x20	16x25
470	471	8x11.5	8x11.5	10x12.5	10x16	10x20	12.5x20	12.5x25	16x31.5
1,000	102	10x12.5	10x16	10x20	12.5x20	12.5x25	16x25	16x31.5	-
2,200	222	12.5x20	12.5x20	12.5x25	16x25	16x31	18x35.5	-	-
3,300	332	12.5x20	12.5x25	16x25	16x31	18x35.5	-	-	-
4,700	472	16x25	16x25	16x31.5	18x35.5	-	-	-	-
6,800	682	16x25	16x31	18x35.5	-	-	-	-	-
10,000	103	16x31	18x36	-	-	-	-	-	-

LEAD SPACING AND DIAMETER (mm)

Case Dia. (Dφ)	5	6.3	8	10	12.5	16	18
Lead Dia. (Dφ)	0.5	0.5	0.6	0.6	0.6	0.8	0.8
Lead Spacing (F)	2.0	2.5	3.5	5.0	5.0	7.5	7.5
Dim. α	0.5	0.5	0.5	0.5	0.5	0.5	0.5

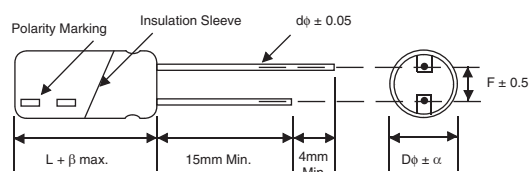

Drawing is representative of parts as supplied in bulk or straight lead format, please see taping specification for details on taped format packaging.

$$\beta = L < 20\text{mm} = 1.5\text{mm}, L \geq 20\text{mm} = 2.0\text{mm}$$



STANDARD VALUES, SPECIFICATIONS AND CASE SIZES (mm)

Part Number	Cap. (μF)	W.V. (Vdc)	Dissipation Factor +20°C/120Hz	Ripple Current Rating (mA) +105°C/120Hz	Max. ESR (Ω) +20°C/120Hz	Load Life Hours @+105°C
NRWA330M6.3V5x11F	33	6.3	0.22	47	11.1	1,000
NRWA470M6.3V5x11F	47		0.22	57	7.8	1,000
NRWA101M6.3V5x11F	100		0.22	82	3.7	1,000
NRWA331M6.3V6.3x11F	330		0.22	170	1.11	1,000
NRWA471M6.3V8x11.5F	470		0.22	230	0.78	1,000
NRWA102M6.3V10x12.5F	1,000		0.22	400	0.36	1,000
NRWA222M6.3V12.5x20F	2,200		0.24	760	0.181	1,000
NRWA332M6.3V12.5x20F	3,300		0.26	890	0.131	1,000
NRWA472M6.3V16x25F	4,700		0.28	1230	0.099	2,000
NRWA682M6.3V16x25F	6,800		0.32	1340	0.078	2,000
NRWA103M6.3V16x31F	10,000		0.40	1610	0.063	2,000
NRWA220M10V5x11F	22	10	0.19	42	14.3	1,000
NRWA330M10V5x11F	33		0.19	51	9.6	1,000
NRWA470M10V5x11F	47		0.19	61	6.7	1,000
NRWA101M10V5x11F	100		0.19	89	3.2	1,000
NRWA221M10V6.3x11F	220		0.19	150	1.43	1,000
NRWA471M10V8x11.5F	470		0.19	250	0.67	1,000
NRWA102M10V10x16F	1,000		0.19	470	0.32	1,000
NRWA222M10V12.5x20F	2,200		0.21	790	0.158	1,000
NRWA332M10V12.5x25F	3,300		0.23	1000	0.166	1,000
NRWA472M10V16x25F	4,700		0.25	1270	0.088	2,000
NRWA682M10V16x31F	6,800		0.29	1540	0.071	2,000
NRWA103M10V18x36F	10,000	0.37	1770	0.058	2,000	
NRWA100M16V5x11F	10	16	0.16	31	26.5	1,000
NRWA220M16V5x11F	22		0.16	45	12.1	1,000
NRWA330M16V5x11F	33		0.16	55	8.0	1,000
NRWA470M16V5x11F	47		0.16	68	5.8	1,000
NRWA101M16V6.3x11F	100		0.16	110	2.7	1,000
NRWA221M16V8x11.5F	220		0.16	190	1.21	1,000
NRWA331M16V8x11.5F	330		0.16	230	0.80	1,000
NRWA471M16V10x12.5F	470		0.16	320	0.66	1,000
NRWA102M16V10x20F	1,000		0.16	560	0.27	1,000
NRWA222M16V12.5x25F	2,200		0.18	950	0.136	1,000
NRWA332M16V16x25F	3,300		0.20	1220	0.101	2,000
NRWA472M16V16x31.5F	4,700	0.22	1490	0.078	2,000	
NRWA682M16V18x35.5F	6,800	0.26	1770	0.063	2,000	
NRWA4R7M25V5x11F	4.7	25	0.14	22	49	1,000
NRWA100M25V5x11F	10		0.14	33	23	1,000
NRWA220M25V5x11F	22		0.14	49	10.8	1,000
NRWA330M25V5x11F	33		0.14	59	7.0	1,000
NRWA470M25V5x11F	47		0.14	71	4.9	1,000
NRWA101M25V6.3x11F	100		0.14	120	2.3	1,000
NRWA221M25V8x11.5F	220		0.14	200	1.1	1,000
NRWA331M25V10x12.5F	330		0.14	290	0.70	1,000
NRWA471M25V10x16F	470		0.14	380	0.49	1,000
NRWA102M25V12.5x20F	1,000		0.14	670	0.23	1,000
NRWA222M25V16x25F	2,200		0.16	1110	0.121	2,000
NRWA332M25V16x31F	3,300	0.18	1380	0.090	2,000	
NRWA472M25V18x35.5F	4,700	0.20	1670	0.071	2,000	
NRWA4R7M35V5x11F	4.7	35	0.12	24	42	1,000
NRWA100M35V5x11F	10		0.12	35	19.9	1,000
NRWA220M35V5x11F	22		0.12	52	9.0	1,000
NRWA330M35V5x11F	33		0.12	64	6.0	1,000
NRWA470M35V6.3x11F	47		0.12	87	4.2	1,000
NRWA101M35V8x11.5F	100		0.12	150	2.0	1,000
NRWA221M35V10x12.5F	220		0.12	260	0.90	1,000
NRWA331M35V10x16F	330		0.12	350	0.60	1,000
NRWA471M35V10x20F	470		0.12	450	0.42	1,000
NRWA102M35V12.5x25F	1,000		0.12	780	0.20	1,000
NRWA222M35V16x31F	2,200		0.14	1280	0.106	2,000
NRWA332M35V18x35.5F	3,300	0.16	1570	0.081	2,000	



STANDARD VALUES, SPECIFICATIONS AND CASE SIZES (mm)

Part Number	Cap. (μF)	W.V. (Vdc)	Dissipation Factor +20°C/120Hz	Ripple Current Rating (mA) +105°C/120Hz	Max. ESR (Ω) +20°C/120Hz	Load Life Hours @+105°C	
NRWAR47M50V5x11F	0.47	50	0.10	8.3	353	1,000	
NRWA1R0M50V5x11F	1.0		0.10	12	168	1,000	
NRWA2R2M50V5x11F	2.2		0.10	18	75	1,000	
NRWA3R3M50V5x11F	3.3		0.10	22	50	1,000	
NRWA4R7M50V5x11F	4.7		0.10	26	35	1,000	
NRWA100M50V5x11F	10		0.10	38	16.6	1,000	
NRWA220M50V5x11F	22		0.10	57	7.5	1,000	
NRWA330M50V6.3x11F	33		0.10	80	5.0	1,000	
NRWA470M50V6.3x11F	47		0.10	96	3.5	1,000	
NRWA101M50V8x11.5F	100		0.10	160	1.66	1,000	
NRWA221M50V10x16F	220		0.10	310	0.75	1,000	
NRWA331M50V10x20F	330		0.10	410	0.50	1,000	
NRWA471M50V12.5x20F	470		0.10	540	0.35	1,000	
NRWA102M50V16x25F	1,000		0.10	950	0.166	2,000	
NRWA222M50V18x36F	2,200		0.12	1480	0.091	2,000	
NRWA3R3M63V5x11F	3.3		63	0.09	23	40	1,000
NRWA4R7M63V5x11F	4.7	0.09		28	32	1,000	
NRWA100M63V5x11F	10	0.09		41	15.0	1,000	
NRWA220M63V6.3x11F	22	0.09		69	6.8	1,000	
NRWA330M63V6.3x11F	33	0.09		85	4.5	1,000	
NRWA470M63V8x11.5F	47	0.09		120	3.2	1,000	
NRWA101M63V10x12.5F	100	0.09		200	1.49	1,000	
NRWA221M63V10x20F	220	0.09		350	0.68	1,000	
NRWA331M63V12.5x20F	330	0.09		480	0.45	1,000	
NRWA471M63V12.5x25F	470	0.09		620	0.32	1,000	
NRWA102M63V16x31.5F	1,000	0.09		1080	0.149	2,000	
NRWAR47M100V5x11F	0.47	100		0.08	8.8	282	1,000
NRWA1R0M100V5x11F	1.0			0.08	13	133	1,000
NRWA2R2M100V5x11F	2.2			0.08	19	60	1,000
NRWA3R3M100V5x11F	3.3			0.08	23	40	1,000
NRWA4R7M100V5x11F	4.7			0.08	30	28	1,000
NRWA100M100V6.3x11F	10		0.08	49	13.3	1,000	
NRWA220M100V8x11.5F	22		0.08	84	6.0	1,000	
NRWA330M100V10x12.5F	33		0.08	120	4.0	1,000	
NRWA470M100V10x16F	47		0.08	160	2.8	1,000	
NRWA101M100V12.5x20F	100		0.08	280	1.33	1,000	
NRWA221M100V16x25F	220		0.08	500	0.60	2,000	
NRWA331M100V16x25F	330		0.08	610	0.40	2,000	
NRWA471M100V16x31.5F	470		0.08	780	0.28	2,000	

RIPPLE CURRENT CORRECTION FACTOR

1. Temperature Factor

Ambient Temperature (°C)	≤+65	+75	+85	+105
Correction Factor	0.45	0.75	0.9	1.0

2. Frequency Factor

Frequency (Hz)	50	120	300	1K	10K	100K
0.47 ~ 3.3μF	0.65	1.00	1.35	1.75	2.30	2.50
4.7 ~ 33μF	0.75	1.00	1.25	1.50	1.75	1.80
47 ~ 1000μF	0.80	1.00	1.15	1.30	1.40	1.50
2200 ~ 10000μF	0.85	1.00	1.03	1.05	1.08	1.08

PART NUMBERING SYSTEM

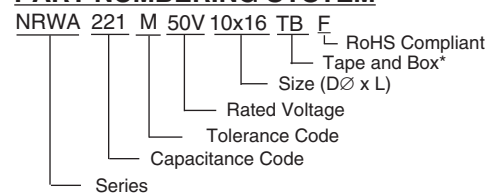

*see tape specification for details

PRECAUTIONS

Please review the notes on correct use, safety and precautions found on pages T10 & T11 of NIC's Electrolytic Capacitor catalog.
Also found at www.niccomp.com/precautions
If in doubt or uncertainty, please review your specific application - process details with NIC's technical support personnel: tpmg@niccomp.com



Miniature Aluminum Electrolytic Capacitors Taping Specifications

STANDARD RADIAL TAPING (5mm LEAD SPACING, FORMED LEADS) TR, TB

Taping Dimensions (mm)

Case Dia. (D ϕ)	4	5	6.3	8
Case Size	4x5	5x5	6.3x5	8x11.5
Dim.	4x7	5x7	6.3x7	6.3x11
d ϕ \pm 0.05	0.45	0.45	0.5	0.5
H \pm 0.75	17.5	17.5	18.5	18.5
F +0.8 ~ -0.2	5.0 -0.2 ~ +0.8			
P	12.7 \pm 1.0			
P ₀	12.7 \pm 0.2			
P ₁	3.85 \pm 0.5 (at end of tape)			
P ₂	6.35 \pm 1.0			
W	18.0 \pm 0.5			
W ₀	11.5 min.			
W ₁	9.0 \pm 0.5			
W ₂	0 ~ 2.5			
H ₀	16.0 \pm 0.5			
l	1.0 max.			
D ₀ ϕ	4.0 \pm 0.2			
Δ h	0 \pm 1.0 (at top of can)			
t	0.7 \pm 0.2 (not including lead)			

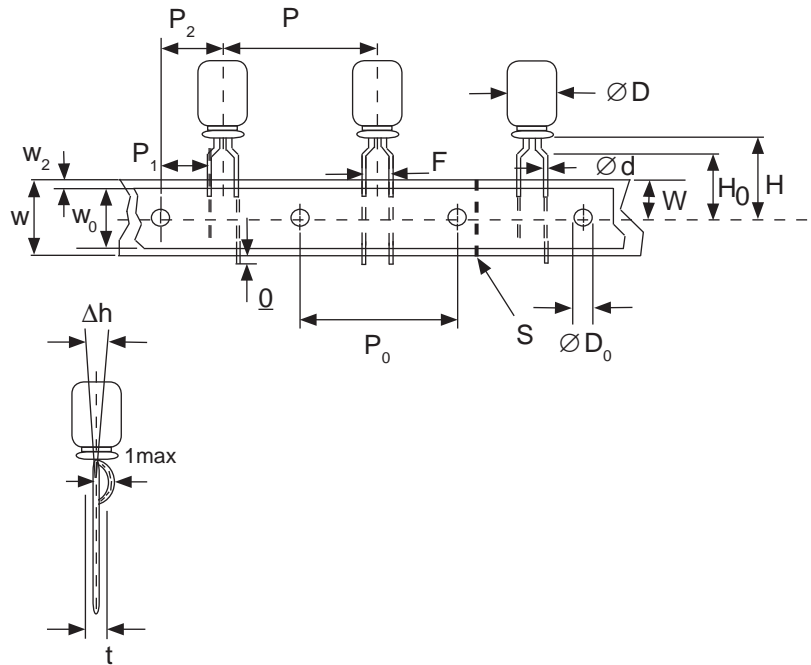

STANDARD RADIAL TAPING (5mm LEAD SPACING, STRAIGHT LEADS) TR, TB

Taping Dimensions (mm)

Case Dia. (D ϕ)	10	12.5
Case Size	All	All
Dim.	All	All
d ϕ \pm 0.05	0.6	0.6
H \pm 0.75	19.0	19.0
F +0.8 ~ -0.2	5.0	5.0
P \pm 1.0	25.4*	
P ₀	12.7 \pm 0.2	
P ₁	3.85	
P ₂	6.35 \pm 1.0	
W	18.0 \pm 0.5	
W ₀	11.5 min	
W ₁	9.0 \pm 0.5	
W ₂	0 ~ 2.5	
H ₀	16.0 \pm 0.5	
l	1.0 max.	
D ₀ ϕ	4.0 \pm 0.2	
Δ h	0 \pm 1.0 (at top of can)	
t	0.7 \pm 0.2 (not including lead)	

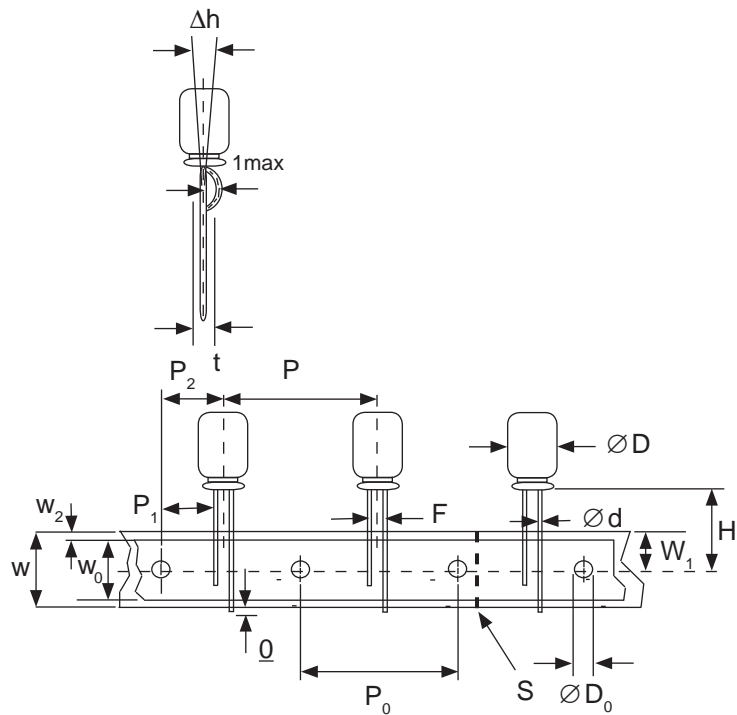

*Optional Taping Specifications

10mm diameter available with P dim. = 12.7mm
(P/N Suffix: TB12.7MMP)

12.5mm diameter available with P dim. = 15mm, P₁ = 5.0mm,
P₀ = 15.0mm & P₂ = 7.5mm (P/N Suffix: TB15MMP)

NOTE: ANODE (+) LEAD FEEDS OFF FIRST.
FOR OPTION OF NEGATIVE (-) LEAD FIRST,
SPECIFY "TRN" OR "TBN".



Miniature Aluminum Electrolytic Capacitors Taping Specifications

SPECIAL RADIAL TAPING (2.5mm LEAD SPACING, FORMED LEADS) TRF1, TBF1

Taping Dimensions (mm)

Case Dia. (D ϕ)	4		5	
Case Size Dim.	4x5 4x7	5x5 5x7	5x11	
d ϕ \pm 0.05	0.45	0.45	0.5	
H \pm 0.75	17.5	17.5	18.5	
H ₀ \pm 0.5	16.0	-	-	
F	2.5 -0.2 ~ +0.8			
P	12.7 \pm 1.0			
P ₀	12.7 \pm 0.2			
P ₁	5.1 \pm 0.5			
P ₂	6.35 \pm 1.0			
W	18.0 \pm 0.5			
W ₀	11.5 min.			
W ₁	9.0 \pm 0.5			
W ₂	0 ~ 1.5			
l	1.0 max.			
D ₀ ϕ	4.0 \pm 0.2			
Δ h	0 \pm 1.0			
t	0.7 \pm 0.2			

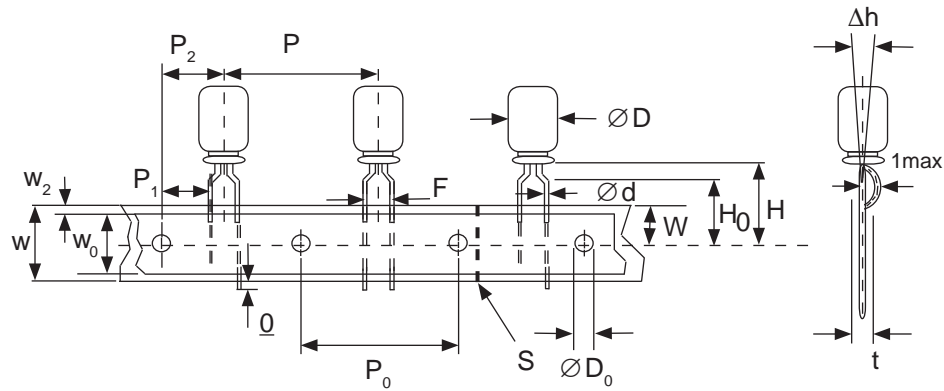

SPECIAL STRAIGHT LEAD TAPING TRST, TBST

Taping Dimensions (mm)

Case Dia. (D ϕ)	4			5			6.3		8	
Case Size Dim.	4x5 4x7	5x5 5x7	5x11		6.3x5 6.3x7	6.3x11	8x11.5			
d ϕ \pm 0.05	0.45	0.45	0.5		0.45	0.5	0.6			
H \pm 0.75	17.5	17.5	18.5		17.5	18.5	20.0			
F +0.8 ~ -0.2	2.0*	2.0	2.0		2.5	2.5	3.5			
P \pm 1.0	12.7 \pm 0.2									
P ₀	12.7 \pm 0.2									
P ₁	5.1	5.1	5.1	5.1	5.1	5.1	4.6			
P ₂	6.35 \pm 1.0									
W	18.0 \pm 0.5									
W ₀	11.5 min.									
W ₁	9.0 \pm 0.5									
W ₂	0 ~ 2.5									
H ₀	16.0 \pm 0.5									
l	1.0 max.									
D ₀ ϕ	4.0 \pm 0.2									
Δ h	0 \pm 1.0 (at top of can)									
t	0.7 \pm 0.2 (not including lead)									

* Parts with 4mm diameter are taped with a slight flare in the lead and a 2.0mm lead-space.

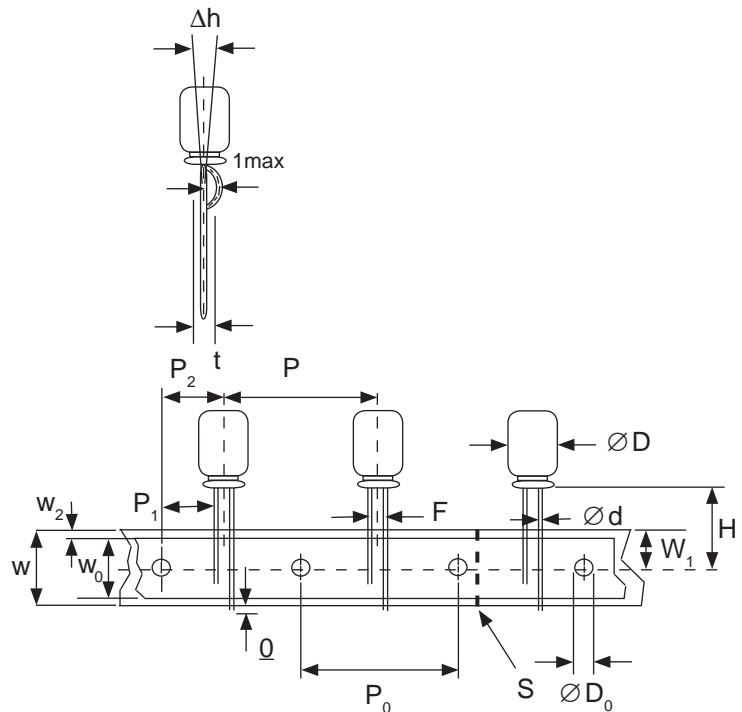

Miniature Aluminum Electrolytic Capacitors Taping Specifications

RADIAL TAPED PACKAGING

Ammo Box (Tape & Box) TB, TBF, TBST

Size of box and component quantity

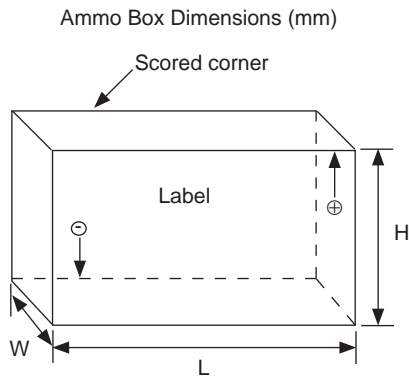

Case Dia (D ϕ) or Case Size	Q'ty per Box (pcs)	Dim. L	Dim. H	Dim. W
4x5, 4x7	2,000	331	175	43
5x5, 5x7	2,000	331	220	43
5x11	2,000	340	255	55
6.3x5, 6.3x7	2,000	331	280	43
6.3x11	2,000	331	280	48
8x11.5, 8x12.5	1,000	335	235	53
10x12.5*	500	335	190	53
10x16*	500	335	300	53
10x20*	500	335	300	55
12.x20*	500	335	300	55
12.5x25*	500	335	300	61

*Special Taping Consult Factory For Availability

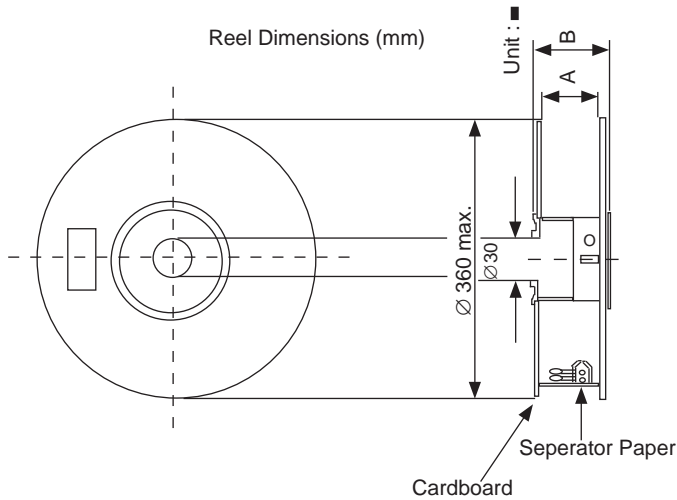

Reel Packages (Tape & Reel) TR, TRF1, TRST

Size of reel and component quantity

Case Dia (D ϕ) or Case Size	Q'ty per Box (pcs)	Dim. A	Dim. B
4 ϕ	1,800	42	52
5 ϕ	1,500	42	52
6.3 ϕ	1,000	42	52
8 ϕ	800	42	52
10x12.5*	600	42	52
10x16*	600	48	56
10x20*	600	52	60
12.x20*	250	52	60
12.5x25*	250	56	64

*Special Taping Consult Factory For Availability

