

## FEATURES

- HIGH CURRENT, SMALL SIZE (UP TO 4 AMPS)
- SURFACE MOUNTABLE CONSTRUCTION
- HIGH INDUCTANCE (UP TO 820 $\mu$ H)
- TAPED AND REELED FOR AUTOMATIC INSERTION
- FOR USE IN DC/DC CONVERTERS, DC/AC INVERTERS
- Pb-FREE COMPATIBLE

**RoHS  
Compliant**  
includes all homogeneous materials

\*See Part Number System for Details



## CHARACTERISTICS

Case Size	NPI32C	NPI43C	NPI52C	NPI54C	NPI73C	NPI75C	NPI104C	NPI105C
Inductance Range	1 ~ 470 $\mu$ H	1 ~ 560 $\mu$ H	1 ~ 560 $\mu$ H	1 ~ 680 $\mu$ H	10 ~ 330 $\mu$ H	10 ~ 470 $\mu$ H	10 ~ 560 $\mu$ H	10 ~ 820 $\mu$ H
Inductance Tolerance	10% (K), 20% (M)							
Operating Temperature Range	-40°C ~ +105°C							
Inductance Change at Isat	-30% max.							
Temperature Raise at Irms	+40°C max.							
Resistance to Solder Heat	260°C for 10 seconds							

## DIMENSIONS (mm)

Series	A	B	C	G (Ref)	H (Ref)	I (Ref)
NPI32C	3.50 $\pm$ 0.3	3.00 $\pm$ 0.3	2.10 $\pm$ 0.3	1.1	3.3	1.30
NPI43C	4.50 $\pm$ 0.3	4.00 $\pm$ 0.3	3.20 $\pm$ 0.3	1.5	4.5	1.75
NPI52C	5.80 $\pm$ 0.3	5.20 $\pm$ 0.3	2.00 $\pm$ 0.3	1.7	5.5	2.15
NPI54C	5.80 $\pm$ 0.3	5.20 $\pm$ 0.3	4.50 $\pm$ 0.3	1.7	5.5	2.15
NPI73C	7.80 $\pm$ 0.3	7.00 $\pm$ 0.3	3.50 $\pm$ 0.5	2.0	7.5	3.0
NPI75C	7.80 $\pm$ 0.3	7.00 $\pm$ 0.3	5.00 $\pm$ 0.5	2.0	7.5	3.0
NPI104C	10.0 $\pm$ 0.3	9.00 $\pm$ 0.3	4.00 $\pm$ 0.5	2.5	9.5	3.75
NPI105C	10.0 $\pm$ 0.4	9.00 $\pm$ 0.4	5.40 $\pm$ 0.4	2.5	9.5	3.75

## REFLOW SOLDERING LAND PATTERN

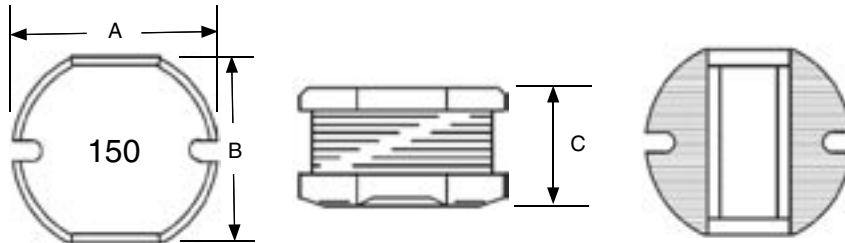
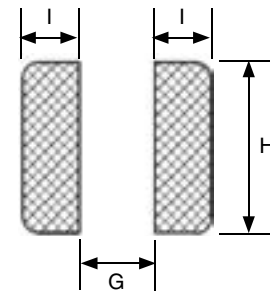

## PART NUMBER SYSTEM

NPI 43 C 4R7 M TR F

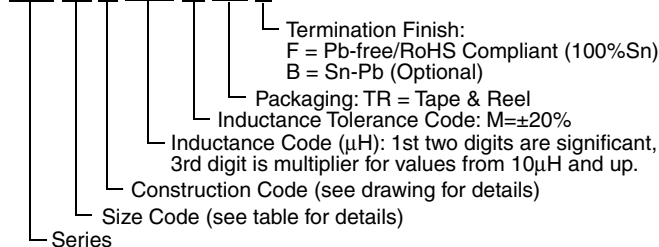

## REFLOW SOLDERING PROFILE

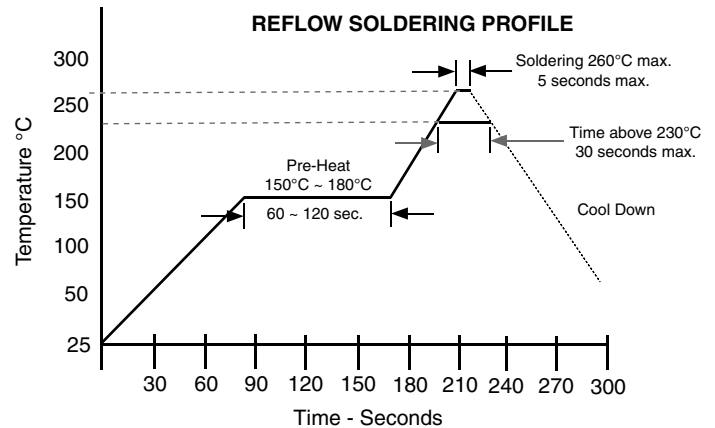

Part Number	STANDARD VALUES - CASE SIZE 32 (3.5 x 3.0 x 2.1mm)			
	Inductance Value (μH)	DC Resistance (Ω)	DC Current Isat/Irms (Amps)	Test Frequency
NPI32C1R0MTRF	1.0±20%	0.04	1.5	7.96MHz
NPI32C1R4MTRF	1.4±20%	0.05	1.5	
NPI32C1R8MTRF	1.8±20%	0.06	0.80	
NPI32C2R2MTRF	2.2±20%	0.08	0.75	
NPI32C2R7MTRF	2.7±20%	0.10	0.75	
NPI32C3R3MTRF	3.3±20%	0.15	0.60	
NPI32C3R9MTRF	3.9±20%	0.20	0.50	
NPI32C4R7MTRF	4.7±20%	0.20	0.50	
NPI32C5R6MTRF	5.6±20%	0.23	0.45	
NPI32C6R8MTRF	6.8±20%	0.25	0.40	
NPI32C8R2MTRF	8.2±20%	0.30	0.40	
NPI32C100MTRF	10±20%	0.35	0.35	
NPI32C120MTRF	12±20%	0.40	0.35	
NPI32C150MTRF	15±20%	0.50	0.30	
NPI32C180MTRF	18±20%	0.55	0.30	
NPI32C220MTRF	22±20%	0.60	0.30	
NPI32C270MTRF	27±20%	0.70	0.30	
NPI32C330MTRF	33±20%	1.0	0.25	
NPI32C390MTRF	39±20%	1.2	0.25	
NPI32C470MTRF	47±20%	1.5	0.20	
NPI32C560MTRF	56±20%	1.8	0.20	
NPI32C680MTRF	68±20%	2.0	0.18	
NPI32C820MTRF	82±20%	2.5	0.16	1KHz
NPI32C101MTRF	100±20%	3.0	0.15	
NPI32C121MTRF	120±20%	3.5	0.14	
NPI32C151MTRF	150±20%	4.0	0.13	
NPI32C181MTRF	180±20%	5.0	0.12	
NPI32C221MTRF	220±20%	5.5	0.10	
NPI32C271MTRF	270±20%	6.0	0.10	
NPI32C331MTRF	330±20%	7.0	0.10	
NPI32C391MTRF	390±20%	8.0	0.10	
NPI32C471MTRF	470±20%	12	0.09	

Maximum +40°C temperature rise at Irms. Maximum -30% inductance change at Isat.

Part Number	STANDARD VALUES - CASE SIZE 43 (4.5 x 4.0 x 3.2mm)			
	Inductance Value (μH)	DC Resistance (Ω)	DC Current Isat/Irms (Amps)	Test Frequency
NPI43C1R0MTRF	1.0 ± 20%	0.03	4.0	7.96MHz
NPI43C1R4MTRF	1.4 ± 20%	0.04	3.5	
NPI43C1R8MTRF	1.8 ± 20%	0.05	3.0	
NPI43C2R2MTRF	2.2 ± 20%	0.06	2.6	
NPI43C2R7MTRF	2.7 ± 20%	0.06	2.2	
NPI43C3R3MTRF	3.3 ± 20%	0.07	2.0	
NPI43C3R9MTRF	3.9 ± 20%	0.07	2.0	
NPI43C4R7MTRF	4.7 ± 20%	0.08	1.9	
NPI43C5R6MTRF	5.6 ± 20%	0.12	1.8	
NPI43C6R8MTRF	6.8 ± 20%	0.14	1.6	
NPI43C8R2MTRF	8.2 ± 20%	0.15	1.4	
NPI43C100MTRF	10 ± 20%	0.19	1.1	2.52MHz
NPI43C120MTRF	12 ± 20%	0.21	1.1	
NPI43C150MTRF	15 ± 20%	0.25	1.0	
NPI43C180MTRF	18 ± 20%	0.3	1.0	
NPI43C220MTRF	22 ± 20%	0.35	0.80	
NPI43C270MTRF	27 ± 20%	0.45	0.75	
NPI43C330MTRF	33 ± 20%	0.6	0.70	
NPI43C390MTRF	39 ± 20%	0.7	0.65	
NPI43C470MTRF	47 ± 20%	0.8	0.60	
NPI43C560MTRF	56 ± 20%	0.85	0.55	
NPI43C680MTRF	68 ± 20%	1.0	0.50	
NPI43C820MTRF	82 ± 20%	1.1	0.46	
NPI43C101MTRF	100 ± 20%	1.2	0.22	1KHz
NPI43C121MTRF	120 ± 20%	1.6	0.20	
NPI43C151MTRF	150 ± 20%	2.0	0.20	
NPI43C181MTRF	180 ± 20%	3.0	0.20	
NPI43C221MTRF	220 ± 20%	3.0	0.20	
NPI43C271MTRF	270 ± 20%	4.0	0.16	
NPI43C331MTRF	330 ± 20%	4.0	0.14	
NPI43C391MTRF	390 ± 20%	5.0	0.12	
NPI43C471MTRF	470 ± 20%	6.0	0.12	
NPI43C561MTRF	560 ± 20%	7.0	0.10	

Maximum +40°C temperature rise at Irms. Maximum -30% inductance change at Isat.

Part Number	STANDARD VALUES - CASE SIZE 52 (5.8 x 5.2 x 2.0mm)			
	Inductance Value (μH)	DC Resistance (Ω)	DC Current Isat/Irms (Amps)	Test Frequency
NPI52C1R0MTRF	1.0±20%	0.03	1.5	7.96MHz
NPI52C1R4MTRF	1.4±20%	0.04	1.5	
NPI52C1R8MTRF	1.8±20%	0.05	1.5	
NPI52C2R2MTRF	2.2±20%	0.06	1.5	
NPI52C2R7MTRF	2.7±20%	0.07	1.5	
NPI52C3R3MTRF	3.3±20%	0.08	1.5	
NPI52C3R9MTRF	3.9±20%	0.09	1.0	
NPI52C4R7MTRF	4.7±20%	0.10	1.0	
NPI52C5R6MTRF	5.6±20%	0.11	1.0	
NPI52C6R8MTRF	6.8±20%	0.14	0.70	
NPI52C8R2MTRF	8.2±20%	0.15	0.65	
NPI52C100MTRF	10±20%	0.30	0.60	
NPI52C120MTRF	12±20%	0.35	0.60	
NPI52C150MTRF	15±20%	0.40	0.55	
NPI52C180MTRF	18±20%	0.45	0.50	
NPI52C220MTRF	22±20%	0.50	0.50	
NPI52C270MTRF	27±20%	0.55	0.45	
NPI52C330MTRF	33±20%	0.60	0.40	
NPI52C390MTRF	39±20%	0.70	0.35	
NPI52C470MTRF	47±20%	0.80	0.30	
NPI52C560MTRF	56±20%	0.90	0.25	
NPI52C680MTRF	68±20%	1.2	0.25	
NPI52C820MTRF	82±20%	1.5	0.22	
NPI52C101MTRF	100±20%	2.0	0.21	1KHz
NPI52C121MTRF	120±20%	3.0	0.20	
NPI52C151MTRF	150±20%	4.0	0.18	
NPI52C181MTRF	180±20%	4.0	0.15	
NPI52C221MTRF	220±20%	4.5	0.15	
NPI52C271MTRF	270±20%	5.0	0.15	
NPI52C331MTRF	330±20%	6.0	0.14	
NPI52C391MTRF	390±20%	6.5	0.14	
NPI52C471MTRF	470±20%	7.0	0.12	
NPI52C561MTRF	560±20%	8.0	0.12	

Maximum +40°C temperature rise at Irms. Maximum -30% inductance change at Isat.

Part Number	STANDARD VALUES - CASE SIZE 54 (5.8 x 5.2 x 4.5mm)			
	Inductance Value (μH)	DC Resistance (Ω)	DC Current Isat/Irms (Amps)	Test Frequency
NPI54C1R0MTRF	1.0 ± 20%	0.018	3.5	7.96MHz
NPI54C1R4MTRF	1.4 ± 20%	0.02	3.5	
NPI54C1R8MTRF	1.8 ± 20%	0.025	3.0	
NPI54C2R2MTRF	2.2 ± 20%	0.03	2.8	
NPI54C2R7MTRF	2.7 ± 20%	0.035	2.6	
NPI54C3R3MTRF	3.3 ± 20%	0.04	2.5	
NPI54C3R9MTRF	3.9 ± 20%	0.05	2.3	
NPI54C4R7MTRF	4.7 ± 20%	0.06	2.6	
NPI54C5R6MTRF	5.6 ± 20%	0.07	2.4	
NPI54C6R8MTRF	6.8 ± 20%	0.08	2.2	
NPI54C8R2MTRF	8.2 ± 20%	0.08	2.0	
NPI54C100MTRF	10 ± 20%	0.09	1.8	
NPI54C120MTRF	12 ± 20%	0.10	1.6	
NPI54C150MTRF	15 ± 20%	0.12	1.5	
NPI54C180MTRF	18 ± 20%	0.15	1.4	
NPI54C220MTRF	22 ± 20%	0.18	1.3	
NPI54C270MTRF	27 ± 20%	0.22	1.2	
NPI54C330KTRF	33 ± 10%	0.26	1.0	
NPI54C390KTRF	39 ± 10%	0.30	0.90	
NPI54C470KTRF	47 ± 10%	0.35	0.85	
NPI54C560KTRF	56 ± 10%	0.40	0.80	
NPI54C680KTRF	68 ± 10%	0.45	0.70	
NPI54C820KTRF	82 ± 10%	0.50	0.70	1KHz
NPI54C101KTRF	100 ± 10%	0.70	0.60	
NPI54C121KTRF	120 ± 10%	0.75	0.60	
NPI54C151KTRF	150 ± 10%	0.90	0.55	
NPI54C181KTRF	180 ± 10%	1.1	0.50	
NPI54C221KTRF	220 ± 10%	1.2	0.40	
NPI54C271KTRF	270 ± 10%	1.5	0.25	
NPI54C331KTRF	330 ± 10%	3.0	0.22	
NPI54C391KTRF	390 ± 10%	3.5	0.20	
NPI54C471KTRF	470 ± 10%	4.0	0.19	
NPI54C561KTRF	560 ± 10%	4.0	0.18	
NPI54C681KTRF	680 ± 10%	4.5	0.15	

Maximum +40°C temperature rise at Irms. Maximum -30% inductance change at Isat.

Part Number	STANDARD VALUES - CASE SIZE 73 (7.8 x 7.0 x 3.5mm)			
	Inductance Value (μH)	DC Resistance (Ω)	DC Current Isat/Irms (Amps)	Test Frequency
NPI73C100MTRF	10 ± 20%	0.0803	1.44	2.52MHz
NPI73C120MTRF	12 ± 20%	0.0897	1.39	
NPI73C150MTRF	15 ± 20%	0.104	1.24	
NPI73C180MTRF	18 ± 20%	0.111	1.12	
NPI73C220MTRF	22 ± 20%	0.129	1.07	
NPI73C270MTRF	27 ± 20%	0.153	0.97	
NPI73C330MTRF	33 ± 20%	0.170	0.85	
NPI73C390MTRF	39 ± 20%	0.217	0.74	
NPI73C470MTRF	47 ± 20%	0.252	0.68	
NPI73C560KTRF	56 ± 10%	0.282	0.64	
NPI73C680KTRF	68 ± 10%	0.332	0.59	
NPI73C820KTRF	82 ± 10%	0.406	0.54	
NPI73C101KTRF	100 ± 10%	0.481	0.51	
NPI73C121KTRF	120 ± 10%	0.536	0.49	
NPI73C151KTRF	150 ± 10%	0.755	0.40	
NPI73C181KTRF	180 ± 10%	1.022	0.36	
NPI73C221KTRF	220 ± 10%	1.200	0.31	
NPI73C271KTRF	270 ± 10%	1.306	0.29	
NPI73C331KTRF	330 ± 10%	1.495	0.28	

Part Number	STANDARD VALUES - CASE SIZE 75 (7.8 x 7.0 x 5.0mm)			
	Inductance Value (μH)	DC Resistance (Ω)	DC Current Isat/Irms (Amps)	Test Frequency
NPI75C100MTRF	10 ± 20%	0.07	2.3	2.52MHz
NPI75C120MTRF	12 ± 20%	0.08	2.0	
NPI75C150MTRF	15 ± 20%	0.09	1.8	
NPI75C180MTRF	18 ± 20%	0.10	1.6	
NPI75C220MTRF	22 ± 20%	0.11	1.5	
NPI75C270MTRF	27 ± 20%	0.12	1.3	
NPI75C330MTRF	33 ± 20%	0.13	1.2	
NPI75C390MTRF	39 ± 20%	0.16	1.1	
NPI75C470KTRF	47 ± 10%	0.18	1.1	
NPI75C560KTRF	56 ± 10%	0.24	0.94	
NPI75C680KTRF	68 ± 10%	0.28	0.85	
NPI75C820KTRF	82 ± 10%	0.37	0.78	
NPI75C101KTRF	100 ± 10%	0.43	0.72	
NPI75C121KTRF	120 ± 10%	0.47	0.66	
NPI75C151KTRF	150 ± 10%	0.64	0.58	
NPI75C181KTRF	180 ± 10%	0.71	0.51	
NPI75C221KTRF	220 ± 10%	0.96	0.49	
NPI75C271KTRF	270 ± 10%	1.11	0.42	
NPI75C331KTRF	330 ± 10%	1.26	0.40	
NPI75C391KTRF	390 ± 10%	1.77	0.36	
NPI75C471KTRF	470 ± 10%	1.96	0.34	

Maximum +40°C temperature rise at Irms. Maximum -30% inductance change at Isat.



Part Number	STANDARD VALUES - CASE SIZE 104 (10.0 x 9.0 x 4.0mm)			
	Inductance Value (μH)	DC Resistance (Ω)	DC Current Isat/Irms (Amps)	Test Frequency
NPI104C100MTRF	10 ± 20%	0.053	2.38	2.52MHz
NPI104C120MTRF	12 ± 20%	0.061	2.13	
NPI104C150MTRF	15 ± 20%	0.070	1.87	
NPI104C180MTRF	18 ± 20%	0.081	1.73	
NPI104C220MTRF	22 ± 20%	0.088	1.60	
NPI104C270MTRF	27 ± 20%	0.100	1.44	
NPI104C330MTRF	33 ± 20%	0.120	1.26	
NPI104C390MTRF	39 ± 20%	0.151	1.20	
NPI104C470MTRF	47 ± 20%	0.170	1.10	
NPI104C560KTRF	56 ± 10%	0.199	1.01	
NPI104C680KTRF	68 ± 10%	0.223	0.91	
NPI104C820KTRF	82 ± 10%	0.252	0.85	
NPI104C101KTRF	100 ± 10%	0.344	0.74	
NPI104C121KTRF	120 ± 10%	0.396	0.69	
NPI104C151KTRF	150 ± 10%	0.544	0.61	
NPI104C181KTRF	180 ± 10%	0.621	0.56	
NPI104C221KTRF	220 ± 10%	0.721	0.53	
NPI104C271KTRF	270 ± 10%	0.949	0.45	
NPI104C331KTRF	330 ± 10%	1.100	0.42	
NPI104C391KTRF	390 ± 10%	1.245	0.38	
NPI104C471KTRF	470 ± 10%	1.526	0.35	
NPI104C561KTRF	560 ± 10%	1.904	0.32	

Maximum +40°C temperature rise at Irms. Maximum -30% inductance change at Isat.

Part Number	STANDARD VALUES - CASE SIZE 105 (10.0 x 9.0 x 5.4mm)			Test Frequency
	Inductance Value (μH)	DC Resistance (Ω)	DC Current Isat/Irms (Amps)	
NPI105C100MTRF	10 ± 20%	0.06	2.60	2.52MHz
NPI105C120MTRF	12 ± 20%	0.07	2.45	
NPI105C150MTRF	15 ± 20%	0.08	2.27	
NPI105C180MTRF	18 ± 20%	0.09	2.15	
NPI105C220MTRF	22 ± 20%	0.10	1.95	
NPI105C270MTRF	27 ± 20%	0.11	1.76	
NPI105C330MTRF	33 ± 20%	0.12	1.50	
NPI105C390MTRF	39 ± 20%	0.14	1.37	
NPI105C470MTRF	47 ± 20%	0.17	1.28	
NPI105C560MTRF	56 ± 20%	0.19	1.17	
NPI105C680MTRF	68 ± 20%	0.22	1.11	
NPI105C820MTRF	82 ± 20%	0.25	1.00	
NPI105C101MTRF	100 ± 20%	0.35	0.97	
NPI105C121MTRF	120 ± 20%	0.40	0.89	
NPI105C151MTRF	150 ± 20%	0.47	0.78	
NPI105C181MTRF	180 ± 20%	0.63	0.72	
NPI105C221MTRF	220 ± 20%	0.73	0.66	
NPI105C271MTRF	270 ± 20%	0.97	0.57	
NPI105C331MTRF	330 ± 20%	1.15	0.52	
NPI105C391MTRF	390 ± 20%	1.30	0.48	
NPI105C471MTRF	470 ± 20%	1.48	0.42	
NPI105C561MTRF	560 ± 20%	1.90	0.33	
NPI105C681MTRF	680 ± 20%	2.25	0.28	
NPI105C821MTRF	820 ± 20%	2.55	0.24	

Maximum +40°C temperature rise at Irms. Maximum -30% inductance change at Isat.



Chip size	CARRIER TAPE DIMENSIONS (mm)								
	Bo	Ao	Ko	P	W	E	F	Po	t
NPI32C	3.7±0.1	3.2±0.1	2.3±0.1	8.0±0.1	12.0±0.1	1.75±0.1	5.5±0.1	4.0±0.1	0.35±0.05
NPI43C	4.6±0.1	4.1±0.1	3.6±0.1	8.0±0.1	12.0±0.1				0.40±0.05
NPI52C	6.0±0.1	5.4±0.1	2.3±0.1	8.0±0.1	12.0±0.1				0.35±0.05
NPI54C	6.1±0.1	5.3±0.1	4.8±0.1	8.0±0.1	12.0±0.1				0.40±0.05
NPI73C	8.1±0.1	7.3±0.1	4.0±0.1	12.0±0.1	16.0±0.1				0.40±0.05
NPI75C	8.1±0.1	7.3±0.1	5.3±0.1	12.0±0.1	16.0±0.1				0.40±0.05
NPI104C	10.3±0.1	9.3±0.1	4.5±0.1	16.0±0.1	24.0±0.1				0.40±0.05
NPI105C	10.3±0.1	9.3±0.1	6.1±0.1	16.0±0.1	24.0±0.1				0.40±0.05

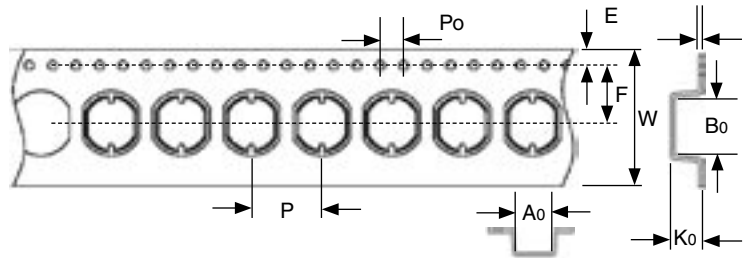

Tape Width	REEL DIMENSIONS (mm)			
	A(mm)	B(mm)	C(mm)	D(mm)
8mm	9.0 ± 0.5	100±1	13±0.5	330
12mm	13.5 ± 0.5			
16mm	16.5 ± 0.5			

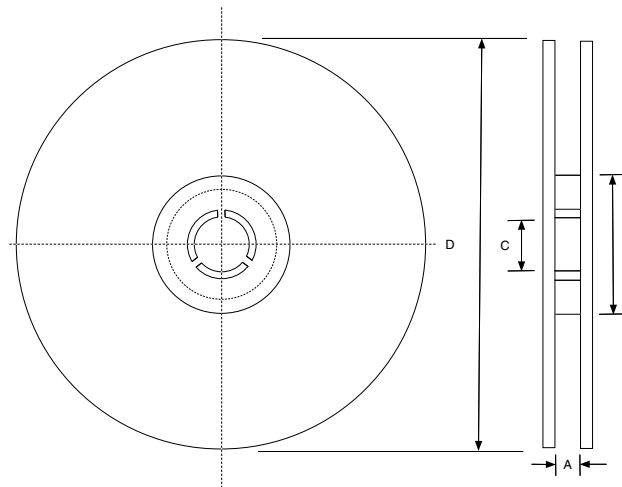

Size	REEL QUANTITY PER CASE SIZE							
	NPI32C	NPI43C	NPI52C	NPI54C	NPI73C	NPI75C	NPI104C	NPI105C
Quantity per reel	3,000	2000	3,000	1,500	1,000	1,000	800	800
Tape Width	12mm	12mm	12mm	12mm	16mm	16mm	24mm	24mm

# Isat and Irms

## NPI & NPIS Series

**Isat (Saturation Current)** - is the current required to **decrease the inductance** value by the specified maximum amount (given as a percentage of the nominal inductance value).

**Irms** - is the current required to **increase the temperature** of the part a maximum specified amount (given as a temperature rise in °C).

In some instances Isat and Irms are shown separately with a maximum decrease in inductance specified at one current rating (Isat) and a maximum temperature rise specified at another current rating (Irms). In other cases one current value is given for both (specified as Idc) and represents the current at which a specified maximum inductance decrease and a maximum specified temperature rise can occur. The graph below illustrates change in inductance and temperature as current increases.

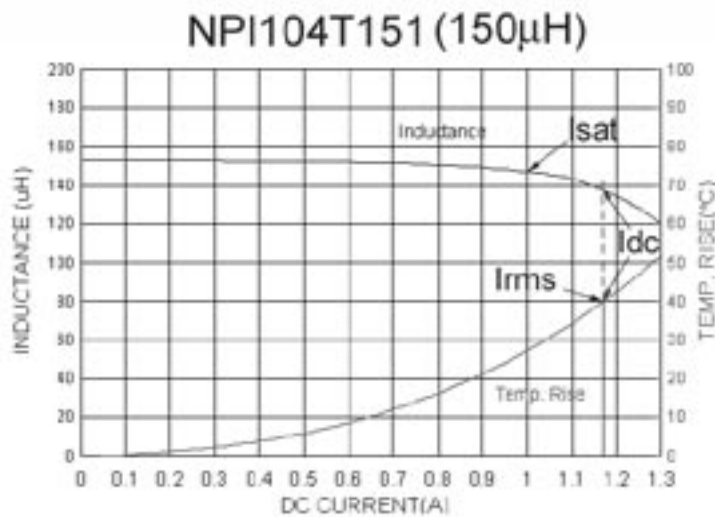

Based on the above graph Isat and Irms could be expressed as follows:

1. Isat and Irms can be shown as separate current values. The Isat current is a value of current that could potentially produce a specified maximum inductance change [-5%, -10%, -20%, etc. of the nominal value]. In this case a 1.0A current has produced a -5% inductance change so 1.0A could be specified as the inductor's Isat current rating. The Irms could be expressed as the current that produces a +40°C temperature rise which in this case is about 1.18A.
2. Both Isat and Irms can be expressed using one current value (Idc). In the above graph 1.18A could be specified as the Idc for the part noting that at 1.18A a potential +40°C temperature rise (equivalent to Irms) and a -10% change in inductance (equivalent to Isat) could occur.