

Finger-shaped

Attachable

Extruded
with solderpins

Extruded
standard length

Die-cast

Profiles

Mounting
accessories

Distance spacers

Fans

ASSMANN WSW components, Hersteller von Standard- und kundenspezifischen Kühlkörpern, bietet ein weites Produktspektrum an frei verfügbaren Strangkühlkörpern an, die nach Kundenwunsch bearbeitet werden können, wie z. B. CNC-Bearbeitung, Lochungen, Fräsungen, Bohrungen und verschiedenste Oberflächenveredelungen, z.B.: Eloxat und Chromat. Die angebotenen Profile haben als Basismaterial standardmäßig eine Aluminiumlegierung AlMgSi0,5 F22. Andere Legierungen sind auf Anfrage lieferbar. Angemerkt sei, dass ASSMANN WSW components, über die frei verfügbaren Profile hinaus, den Kunden vor Ort bei der Entwicklung von applikations spezifischen Kühlkörpern hinsichtlich der Wärmeleitberechnung, dem Design-In und bei der Layoutfindung, intensiv auf Basis der langjährigen Erfahrung, berät. Die Erfahrungen aus unserer eigenen Fertigung in der Slowakei fließen hier direkt mit ein. ASSMANN WSW components unterstützt bei allen anfallenden Fragen rund um das Thema „Thermal Management“.

Gerne beraten wir Sie bei der Umsetzung Ihrer Projekte.

ASSMANN WSW components , manufacturer of standard- and customer specific heatsinks, offer a wide range of generally standard extruded heatsinks, which can be machined according to customer request, e.g.: CNC-machining, hole pattern, drilling and various surfaces e.g. anodization and chromate. These offered extruded heatsinks use Aluminium alloy AlMgSi0,5 F22 as the standard base material. Other base materials are available on request. Beyond offering standard extruded heatsinks, ASSMANN WSW components supports the customer during the development phase of an application specific heatsink with regard to heat calculation, design-in and layout, based on the experience of more than 38 years heatsink production. ASSMANN WSW components supports the customers on all questions around the product range `Thermal Management`.

We would appreciate to receive your request.

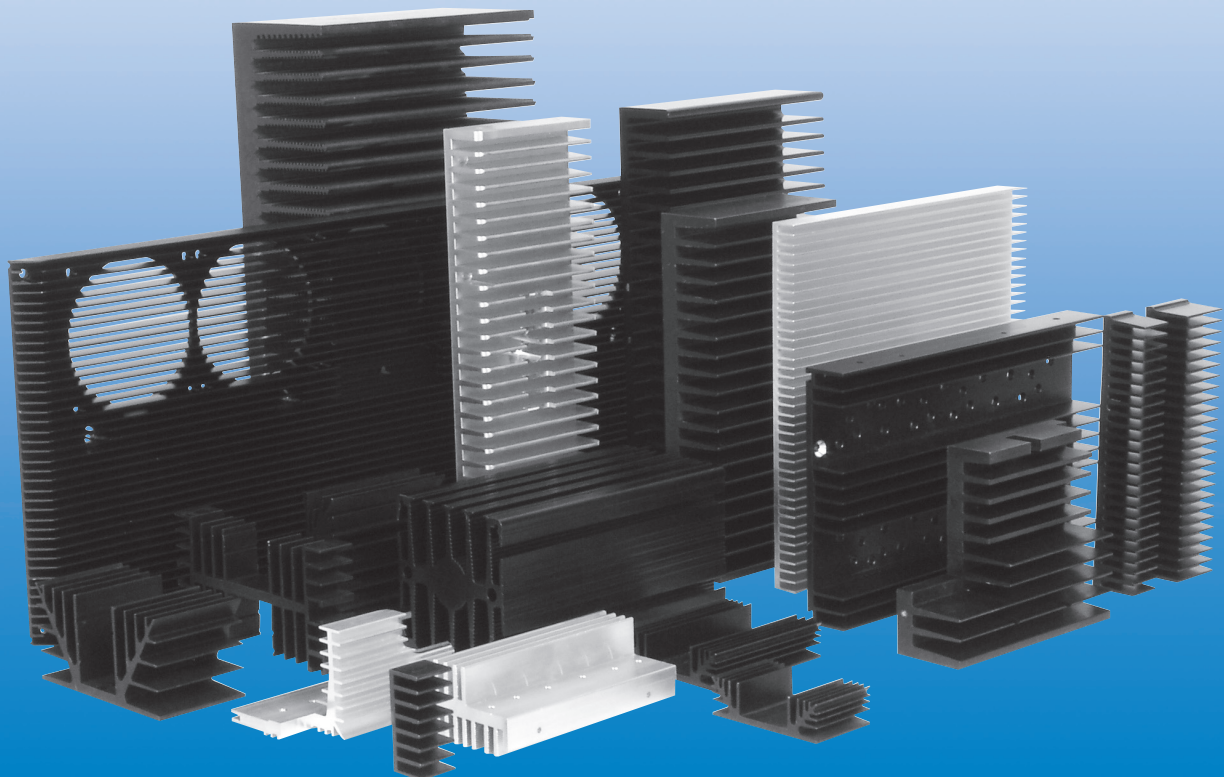

Produktbeschreibung

Seite

Profilkühlkörper, Strangkühlkörper - Kammprofile Breite: 28mm - 600mm	60
Profilkühlkörper, Strangkühlkörper mit Montagefläche, Breite: 25mm - 165mm	74
Profilkühlkörper, Strangkühlkörper als Gehäuserückwand	88
Profilkühlkörper, Strangkühlkörper mit extrudierten M3 - Gewidekanälen	89
Profilkühlkörper, Spezialkühlkörper	92
U-Profilkühlkörper	95
Winkel-Profilkühlkörper	96
Flach-Profilkühlkörper	97

Product description

page

Profile heatsinks, Extruded heatsinks - comb shape, width: 28mm - 600mm	60
Profile heatsinks, Extruded heatsinks with mounting plate, width: 25mm - 165mm	74
Profile heatsinks, Extruded heatsinks as cabinet-backs	88
Profile heatsinks, Extruded heatsinks with extruded M3 - thread gutter	89
Profile heatsinks, Special heatsinks	92
U-Profile heatsinks	95
Angle-Profile heatsinks	96
Flat-Profile heatsinks	97



Finger-shaped

Attachable

Extruded with solderpins

Extruded standard length

Die-cast



































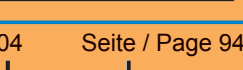
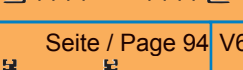
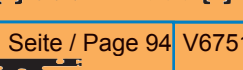





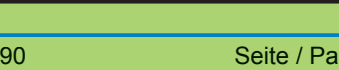

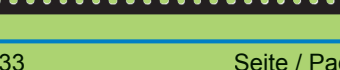

Profiles

Mounting accessories

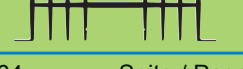
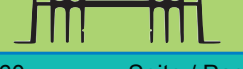
Distance spacers

























































Fans

Profilübersicht geordnet nach Wärmewiderstand R_{th} bei 50mm Länge
Heatsinks chart classified in categories of thermal resistance R_{th} at 50mm length

V9000  Seite / Page 71	V9016  Seite / Page 72	V9178  Seite / Page 68	
V9179  Seite / Page 68	V9180  Seite / Page 68	V9181  Seite / Page 69	
V9182  Seite / Page 69	V9183  Seite / Page 71	V9185  Seite / Page 72	
V9187  Seite / Page 73	V9188  Seite / Page 73	V9189  Seite / Page 73	
V5436  Seite / Page 67	V5496  Seite / Page 67	V6264  Seite / Page 72	
V6434  Seite / Page 70	V6506  Seite / Page 66	V6750  Seite / Page 66	
V7495  Seite / Page 70	V7728  Seite / Page 69	V7877  Seite / Page 70	
V6520  Seite / Page 82	V5500  Seite / Page 86	V5308  Seite / Page 86	V7454  Seite / Page 85
V5304  Seite / Page 94	V9190  Seite / Page 94	V6509  Seite / Page 94	V6751  Seite / Page 71
V7488  Seite / Page 65	V9019  Seite / Page 64	V5435  Seite / Page 65	
V7486  Seite / Page 67	V7493  Seite / Page 64	V5390  Seite / Page 87	
V5373  Seite / Page 87	V5433  Seite / Page 84	V5434  Seite / Page 85	
V5501  Seite / Page 87	V4365  Seite / Page 83	V7260  Seite / Page 79	V9177  Seite / Page 64
V5264  Seite / Page 84	V7660  Seite / Page 91	V4511  Seite / Page 80	V5512  Seite / Page 78
V7498  Seite / Page 65	V4432  Seite / Page 81	V5513  Seite / Page 82	

0,5 - 1 K/W
 1 - 1,5 K/W
 1,5 - 2 K/W

Profilübersicht geordnet nach Wärmewiderstand R_{th} bei 50mm Länge
Heatsinks chart classified in categories of thermal resistance R_{th} at 50mm length

V7331  Seite / Page 63	V5302  Seite / Page 81	V5481  Seite / Page 81		
V7749  Seite / Page 83	V7750  Seite / Page 62	V7500  Seite / Page 84		
V6716  Seite / Page 90	V6716Z  Seite / Page 89	V7496  Seite / Page 90	V6690  Seite / Page 60	V6290  Seite / Page 60
V4329  Seite / Page 85	V3940  Seite / Page 83	V4493  Seite / Page 86		
V5497  Seite / Page 66	V5805  Seite / Page 63	V5517  Seite / Page 79		
V7957  Seite / Page 63	V5745  Seite / Page 88	V5511  Seite / Page 80	V7792  Seite / Page 92	
V7502  Seite / Page 90	V7980  Seite / Page 91	V5583  Seite / Page 91	V7479  Seite / Page 61	V7702  Seite / Page 89
V5510  Seite / Page 78	V5224  Seite / Page 76	V4381  Seite / Page 78	V5380  Seite / Page 76	
V7172  Seite / Page 80	V4429  Seite / Page 77	V5331  Seite / Page 77	V7480  Seite / Page 79	
V5440  Seite / Page 61	V7950  Seite / Page 62	V7176  Seite / Page 62	V5428  Seite / Page 77	
V9156  Seite / Page 76	V7942  Seite / Page 61	V7966  Seite / Page 92	V5330  Seite / Page 75	
V7982  Seite / Page 89	V5220  Seite / Page 75	V5195  Seite / Page 75	V4330  Seite / Page 74	
V5474  Seite / Page 95	V5252  Seite / Page 95	V6560  Seite / Page 74	V5229  Seite / Page 74	V7949  Seite / Page 60
V5333  Seite / Page 95	V5251  Seite / Page 95	V5616  Seite / Page 95	V7268  Seite / Page 95	V7969  Seite / Page 95
V4874  Seite / Page 95				

1,5 - 2 K/W

 4,5 - 6 K/W

Finger-shaped

Attachable

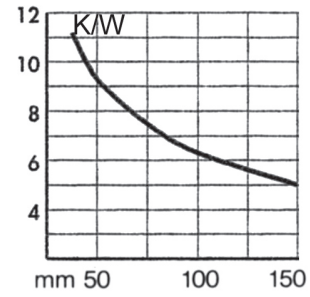
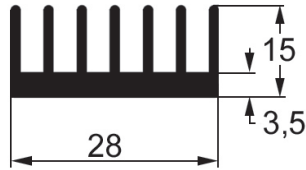

Bestellcode
 Ordercode

V 7949

Extruded
 with solderpins

Extruded
 standard length

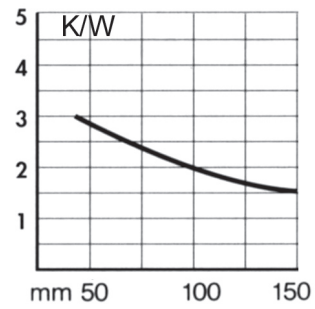
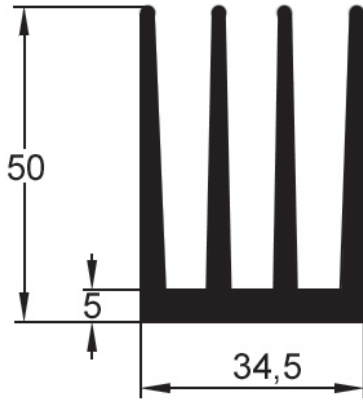

Bestellcode
 Ordercode

V 6690

Die-cast

Profiles

Mounting
 accessories

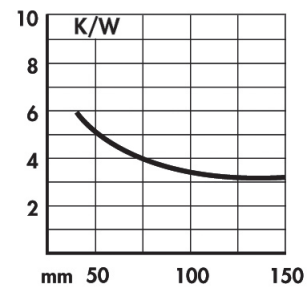
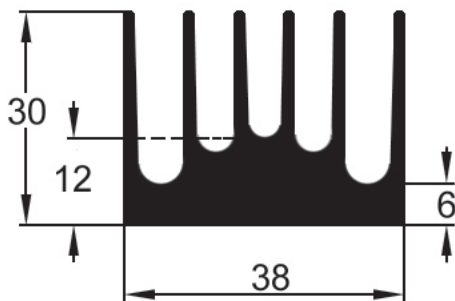

Bestellcode
 Ordercode

V 6290

Distance spacers

Fans

Freimaßtoleranz für Profile DIN1748, DIN17615 / Free dimensional tolerance for profiles DIN1748, DIN17615
 Freimaßtoleranz für die Bearbeitung DIN7168, mittel / Free dimensional tolerance for the handling DIN7168

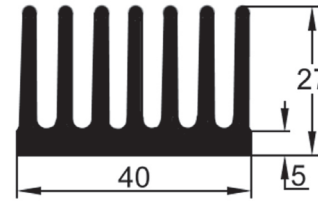
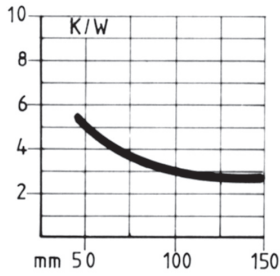

Bestellcode
 Ordercode

V 7479

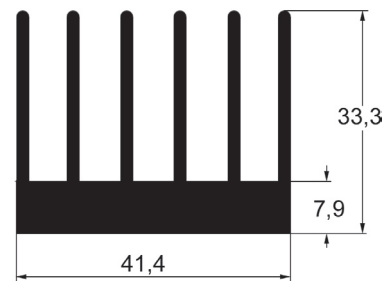
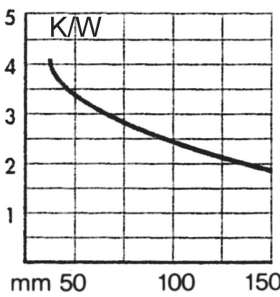

Bestellcode
 Ordercode

V 7942

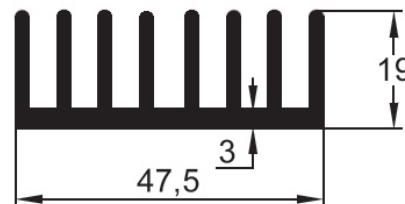
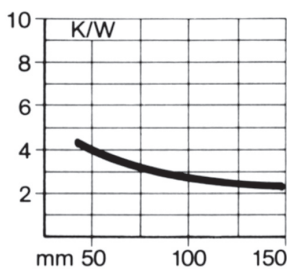

Bestellcode
 Ordercode

V 5440

Freimaßtoleranz für Profile DIN1748, DIN17615 / Free dimensional tolerance for profiles DIN1748, DIN17615
 Freimaßtoleranz für die Bearbeitung DIN7168, mittel / Free dimensional tolerance for the handling DIN7168

Finger-shaped

Attachable

Extruded with solderpins

Extruded standard length

Die-cast

Profiles

Mounting accessories

Distance spacers

Fans

Finger-shaped

Attachable

Extruded
with solderpins

Extruded
standard length

Die-cast

Profiles

Mounting
accessories

Distance spacers

Fans

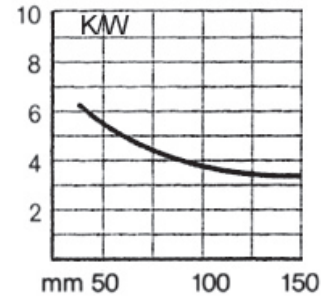
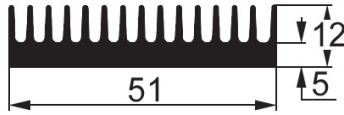

Bestellcode
Ordercode

V 7950

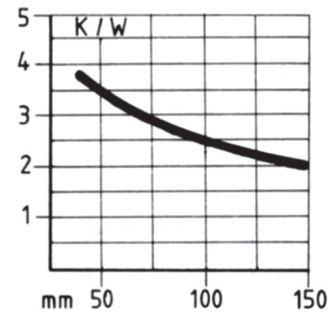
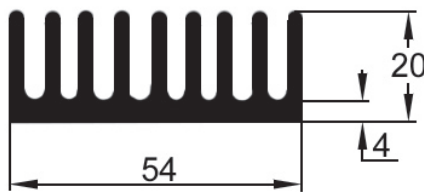

Bestellcode
Ordercode

V 7176

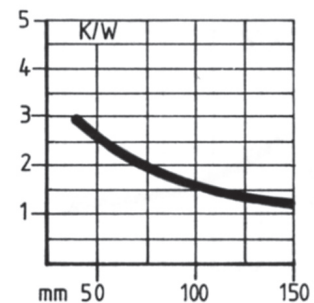
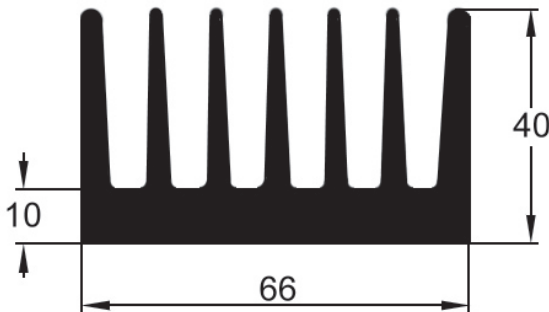

Bestellcode
Ordercode

V 7750

Freimaßtoleranz für Profile DIN1748, DIN17615 / Free dimensional tolerance for profiles DIN1748, DIN17615
 Freimaßtoleranz für die Bearbeitung DIN7168, mittel / Free dimensional tolerance for the handling DIN7168

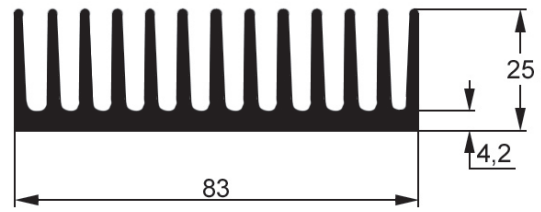
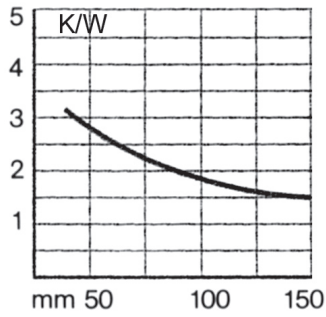

Bestellcode
 Ordercode

V 7957

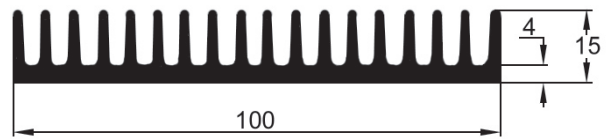
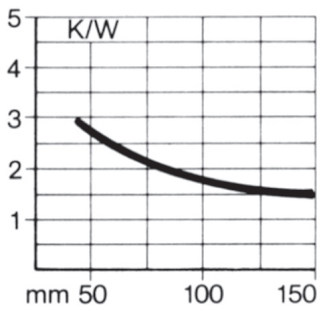

Bestellcode
 Ordercode

V 5805

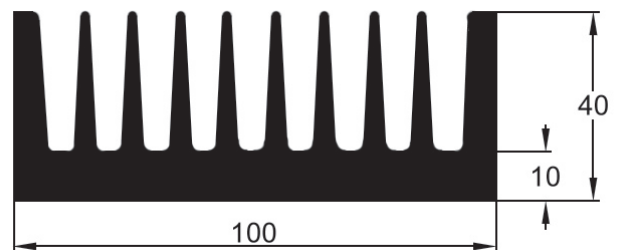
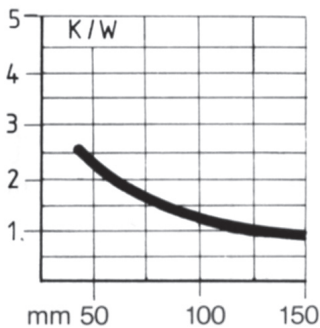

Bestellcode
 Ordercode

V 7331

Freimaßtoleranz für Profile DIN1748, DIN17615 / Free dimensional tolerance for profiles DIN1748, DIN17615
 Freimaßtoleranz für die Bearbeitung DIN7168, mittel / Free dimensional tolerance for the handling DIN7168

Finger-shaped

Attachable

Extruded
 with solderpins

Extruded
 standard length

Die-cast

Profiles

Mounting
 accessories

Distance spacers

Fans

Finger-shaped

Attachable

Extruded with solderpins

Extruded standard length

Die-cast

Profiles

Mounting accessories

Distance spacers

Fans

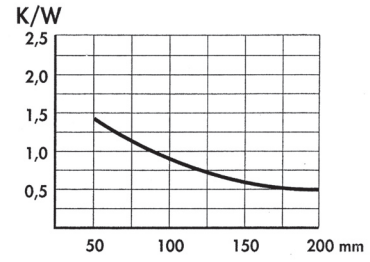
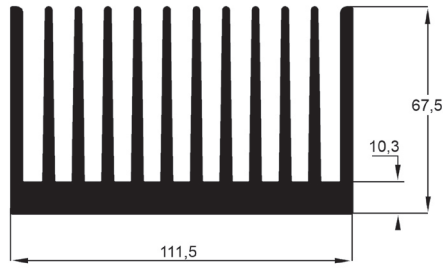

Bestellcode
Ordercode

V 9177

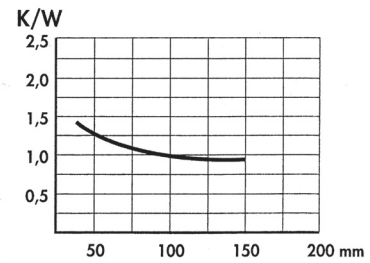
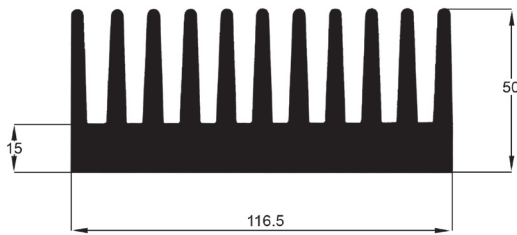

Bestellcode
Ordercode

V 9019

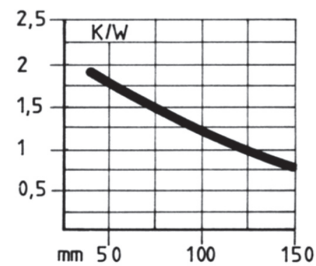
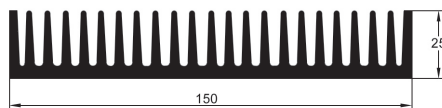

Bestellcode
Ordercode

V 7493

Freimaßtoleranz für Profile DIN1748, DIN17615 / Free dimensional tolerance for profiles DIN1748, DIN17615
Freimaßtoleranz für die Bearbeitung DIN7168, mittel / Free dimensional tolerance for the handling DIN7168

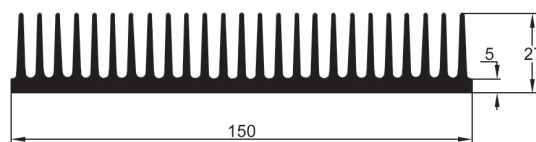
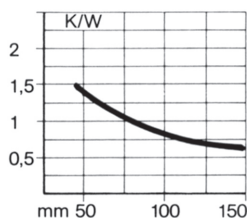

Bestellcode
 Ordercode

V 5435

Finger-shaped

Attachable

Extruded
 with solderpins

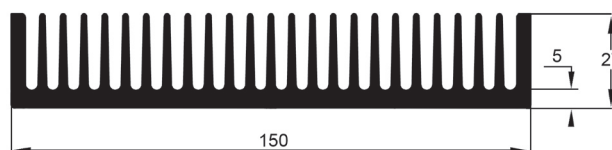
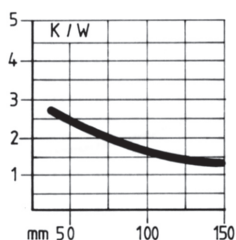

Bestellcode
 Ordercode

V 7498

Extruded
 standard length

Die-cast

Profiles

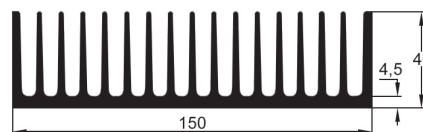
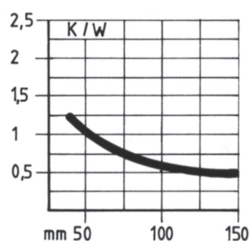

Bestellcode
 Ordercode

V 7488

Mounting
 accessories

Distance spacers

Fans

Freimaßtoleranz für Profile DIN1748, DIN17615 / Free dimensional tolerance for profiles DIN1748, DIN17615
 Freimaßtoleranz für die Bearbeitung DIN7168, mittel / Free dimensional tolerance for the handling DIN7168

Finger-shaped

Attachable

Extruded with solderpins

Extruded standard length

Die-cast

Profiles

Mounting accessories

Distance spacers

Fans

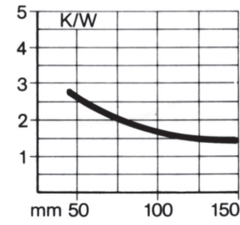

Bestellcode
 Ordercode

V 5497

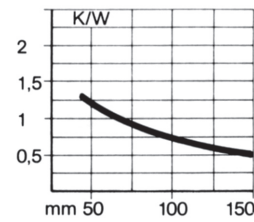
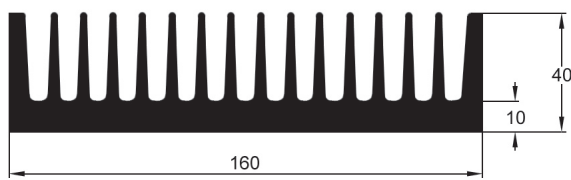

Bestellcode
 Ordercode

V 6506

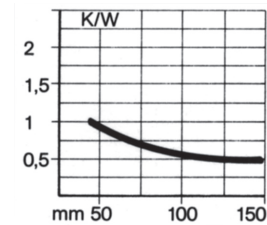
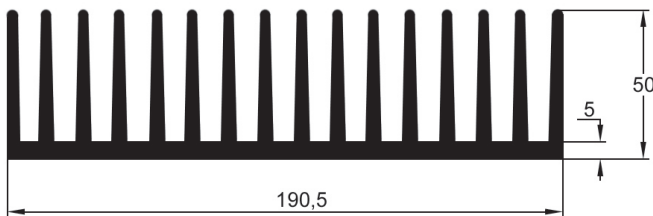

Bestellcode
 Ordercode

V 6750

Freimaßtoleranz für Profile DIN1748, DIN17615 / Free dimensional tolerance for profiles DIN1748, DIN17615
 Freimaßtoleranz für die Bearbeitung DIN7168, mittel / Free dimensional tolerance for the handling DIN7168

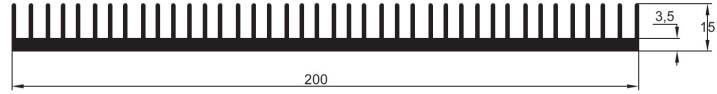
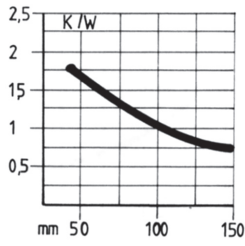

Bestellcode
 Ordercode

V 7486

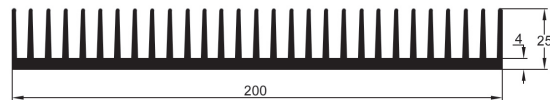
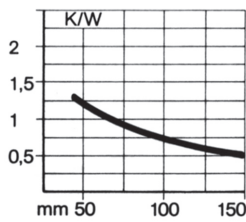

Bestellcode
 Ordercode

V 5496

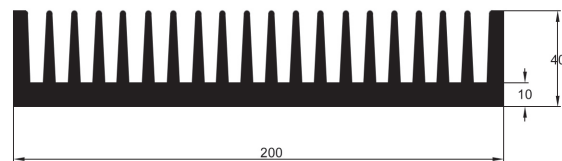
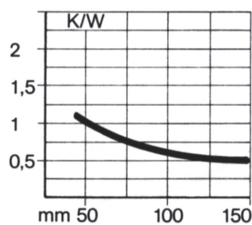

Bestellcode
 Ordercode

V 5436

Freimaßtoleranz für Profile DIN1748, DIN17615 / Free dimensional tolerance for profiles DIN1748, DIN17615
 Freimaßtoleranz für die Bearbeitung DIN7168, mittel / Free dimensional tolerance for the handling DIN7168

Finger-shaped

Attachable

Extruded
 with solderpins

Extruded
 standard length

Die-cast

Profiles

Mounting
 accessories

Distance spacers

Fans

Finger-shaped

Attachable

Extruded
with solderpins

Extruded
standard length

Die-cast

Profiles

Mounting
accessories

Distance spacers

Fans

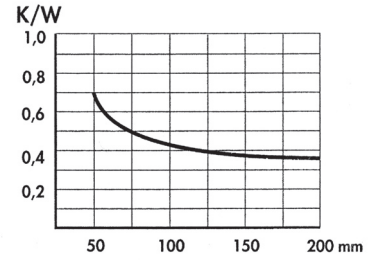
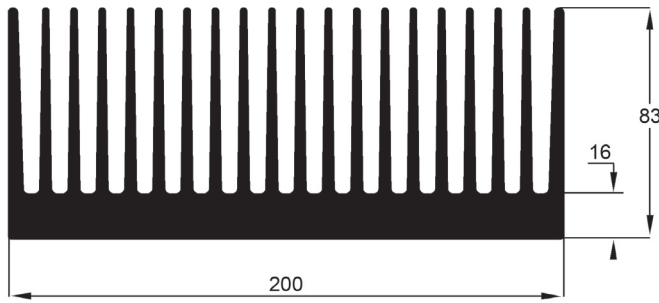

Bestellcode
Ordercode

V 9178

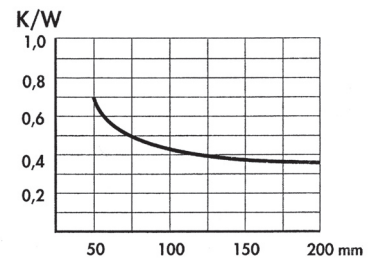
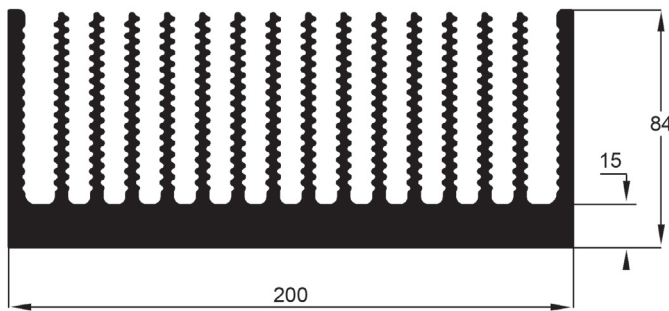

Bestellcode
Ordercode

V 9179

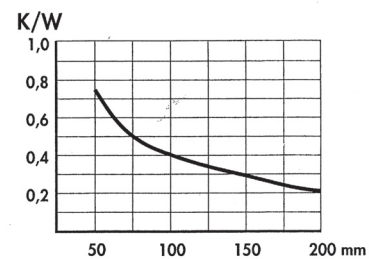
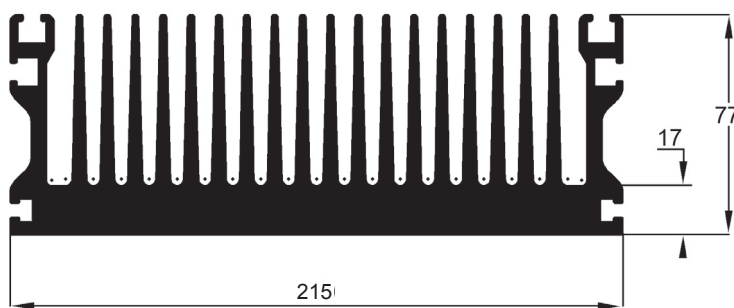

Bestellcode
Ordercode

V 9180

Freimaßtoleranz für Profile DIN1748, DIN17615 / Free dimensional tolerance for profiles DIN1748, DIN17615
Freimaßtoleranz für die Bearbeitung DIN7168, mittel / Free dimensional tolerance for the handling DIN7168

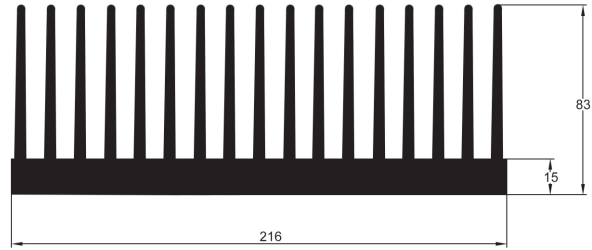
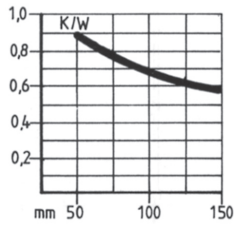

Bestellcode
 Ordercode

V 7728

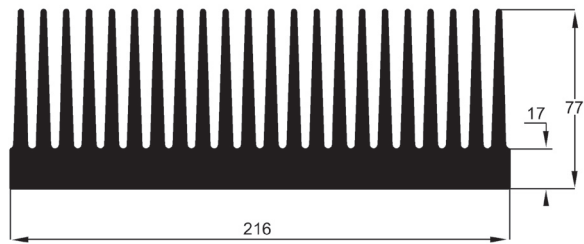
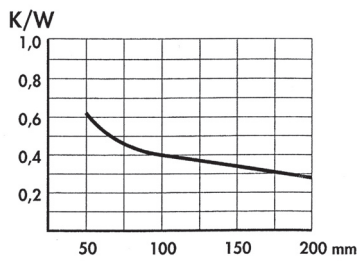

Bestellcode
 Ordercode

V 9181

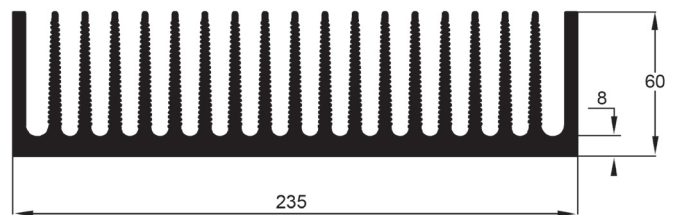
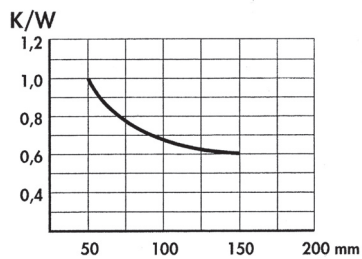

Bestellcode
 Ordercode

V 9182

Freimaßtoleranz für Profile DIN1748, DIN17615 / Free dimensional tolerance for profiles DIN1748, DIN17615
 Freimaßtoleranz für die Bearbeitung DIN7168, mittel / Free dimensional tolerance for the handling DIN7168

Finger-shaped

Attachable

Extruded
 with solderpins

Extruded
 standard length

Die-cast

Profiles

Mounting
 accessories

Distance spacers

Fans

Finger-shaped

Attachable

Extruded
with solderpins

Extruded
standard length

Die-cast

Profiles

Mounting
accessories

Distance spacers

Fans

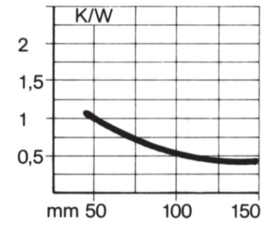
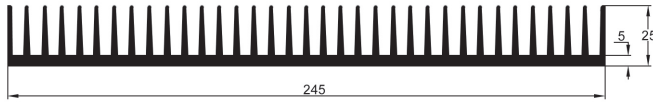

Bestellcode
Ordercode

V 6434

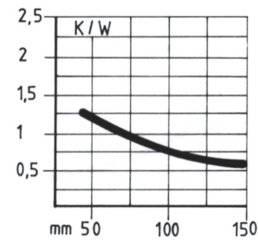
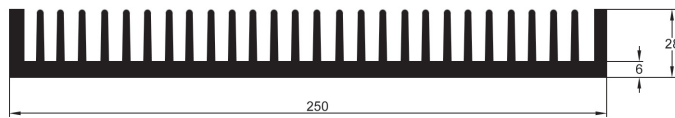

Bestellcode
Ordercode

V 7495

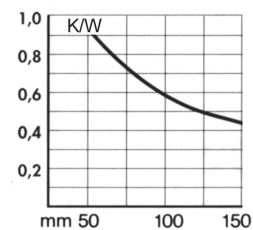
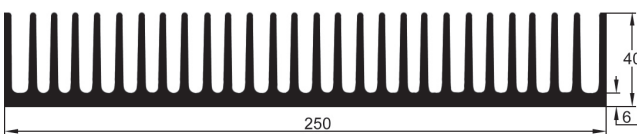

Bestellcode
Ordercode

V 7877

Freimaßtoleranz für Profile DIN1748, DIN17615 / Free dimensional tolerance for profiles DIN1748, DIN17615
Freimaßtoleranz für die Bearbeitung DIN7168, mittel / Free dimensional tolerance for the handling DIN7168

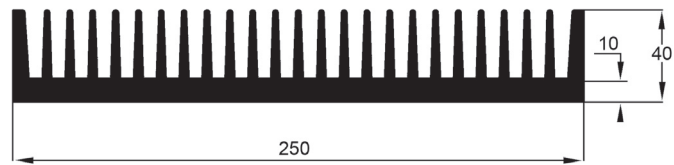
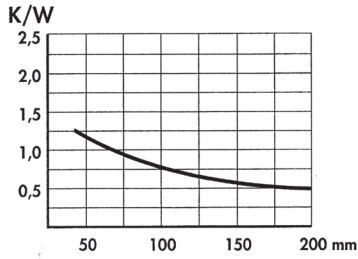

Bestellcode
 Ordercode

V 9183

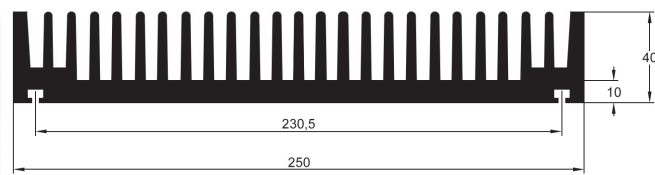
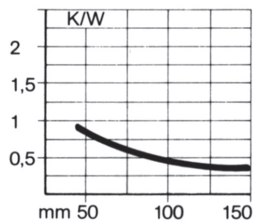

Bestellcode
 Ordercode

V 6751

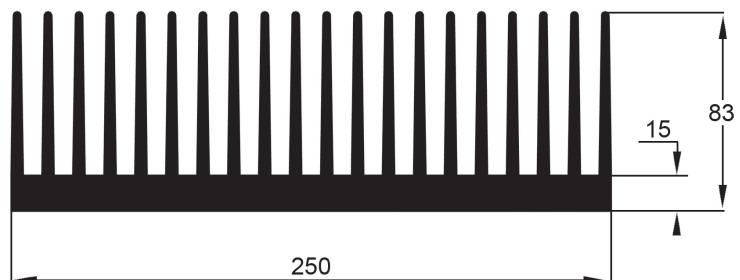
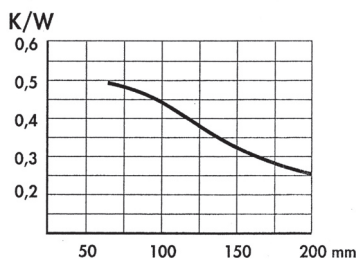

Bestellcode
 Ordercode

V 9000

Freimaßtoleranz für Profile DIN1748, DIN17615 / Free dimensional tolerance for profiles DIN1748, DIN17615
 Freimaßtoleranz für die Bearbeitung DIN7168, mittel / Free dimensional tolerance for the handling DIN7168

Finger-shaped

Attachable

Extruded
 with solderpins

Extruded
 standard length

Die-cast

Profiles

Mounting
 accessories

Distance spacers

Fans

Finger-shaped

Attachable

Extruded
with solderpins

Extruded
standard length

Die-cast

Profiles

Mounting
accessories

Distance spacers

Fans

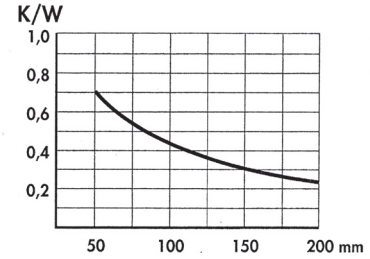
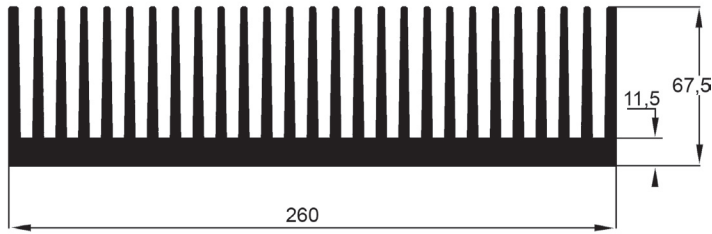

Bestellcode
Ordercode

V 9185

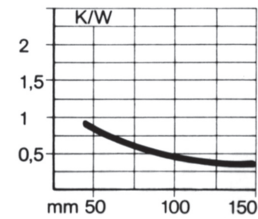
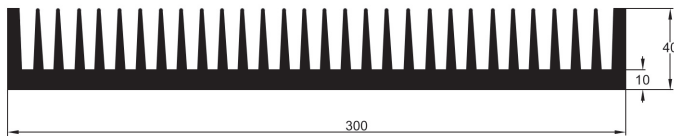

Bestellcode
Ordercode

V 6264

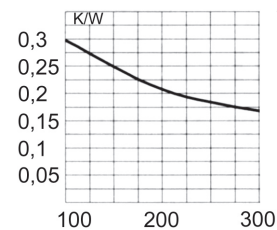
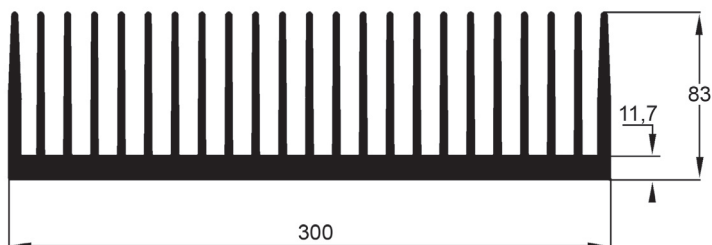

Bestellcode
Ordercode

V 9016

Freimaßtoleranz für Profile DIN1748, DIN17615 / Free dimensional tolerance for profiles DIN1748, DIN17615
Freimaßtoleranz für die Bearbeitung DIN7168, mittel / Free dimensional tolerance for the handling DIN7168

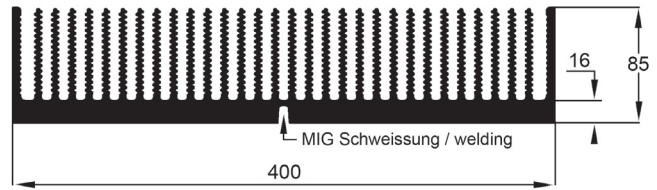
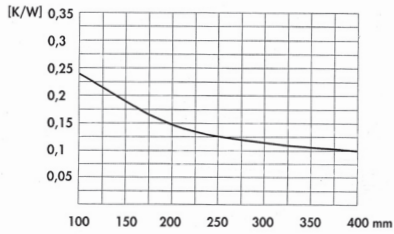

Bestellcode
 Ordercode

V 9187

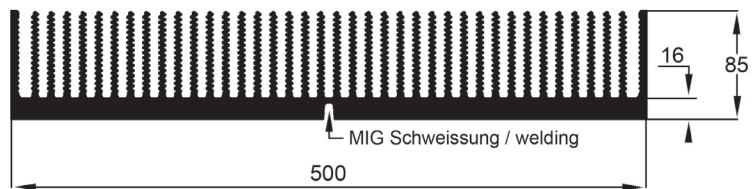
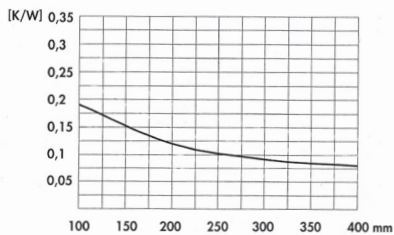

Bestellcode
 Ordercode

V 9188

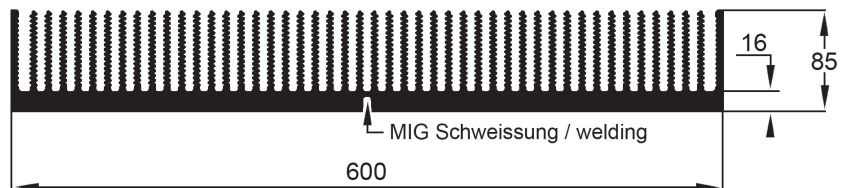
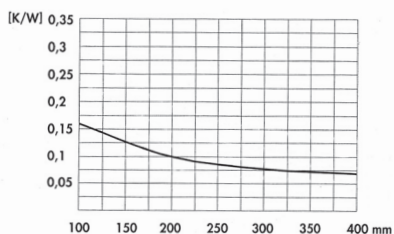

Bestellcode
 Ordercode

V 9189

Freimaßtoleranz für Profile DIN1748, DIN17615 / Free dimensional tolerance for profiles DIN1748, DIN17615
 Freimaßtoleranz für die Bearbeitung DIN7168, mittel / Free dimensional tolerance for the handling DIN7168

Finger-shaped

Attachable

Extruded with solderpins

Extruded standard length

Die-cast

Profiles

Mounting accessories

Distance spacers

Fans

Finger-shaped

Attachable

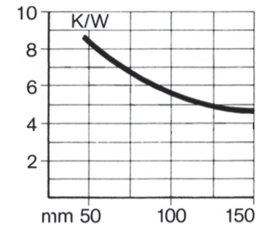
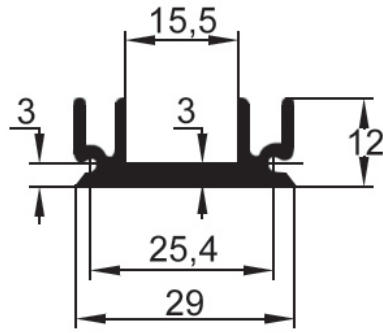

Bestellcode
 Ordercode

V 6560

Extruded
 with solderpins

Extruded
 standard length

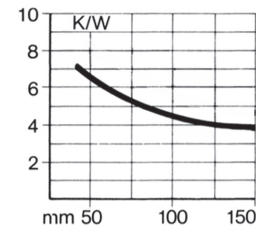
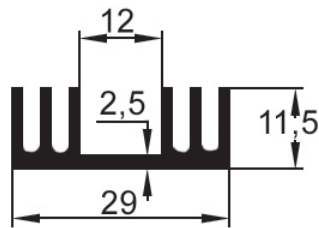

Die-cast

Bestellcode
 Ordercode

V 4330

Profiles

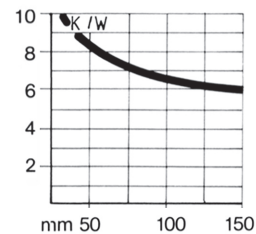
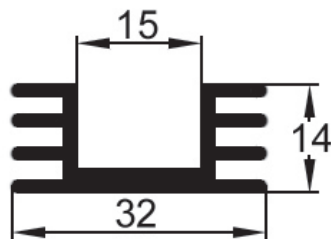

Mounting
 accessories

Bestellcode
 Ordercode

V 5229

Distance spacers

Fans

Freimaßtoleranz für Profile DIN1748, DIN17615 / Free dimensional tolerance for profiles DIN1748, DIN17615
 Freimaßtoleranz für die Bearbeitung DIN7168, mittel / Free dimensional tolerance for the handling DIN7168

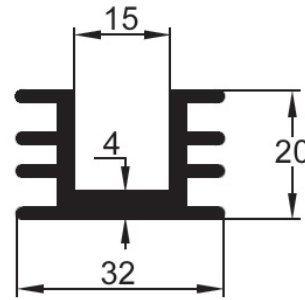
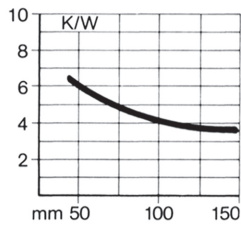

Bestellcode
 Ordercode

V 5220

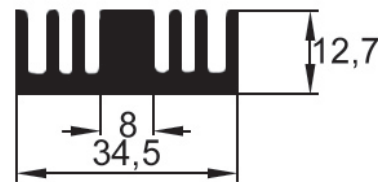
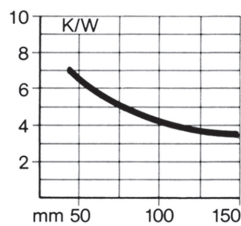

Bestellcode
 Ordercode

V 5195

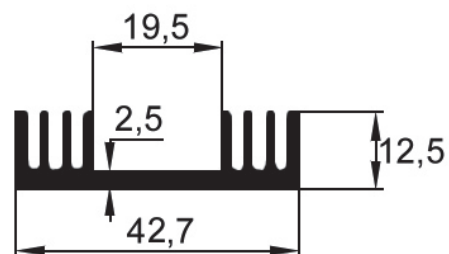
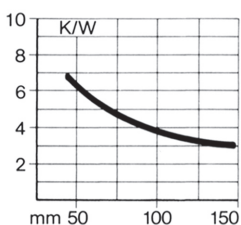

Bestellcode
 Ordercode

V 5330

Freimaßtoleranz für Profile DIN1748, DIN17615 / Free dimensional tolerance for profiles DIN1748, DIN17615
 Freimaßtoleranz für die Bearbeitung DIN7168, mittel / Free dimensional tolerance for the handling DIN7168

Finger-shaped

Attachable

Extruded
 with solderpins

Extruded
 standard length

Die-cast

Profiles

Mounting
 accessories

Distance spacers

Fans

Finger-shaped

Attachable

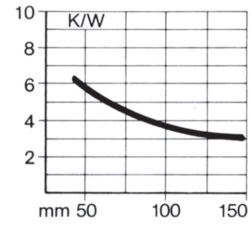
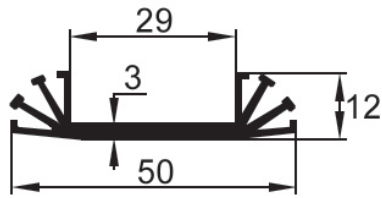

Bestellcode
 Ordercode

V 5380

Extruded
 with solderpins

Extruded
 standard length

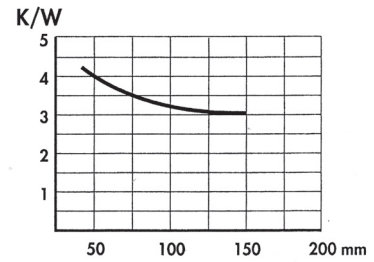
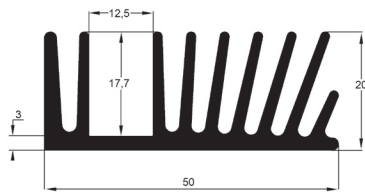

Bestellcode
 Ordercode

V 9156

Die-cast

Profiles

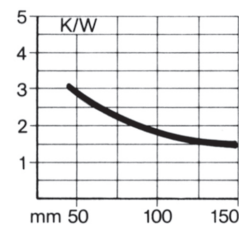
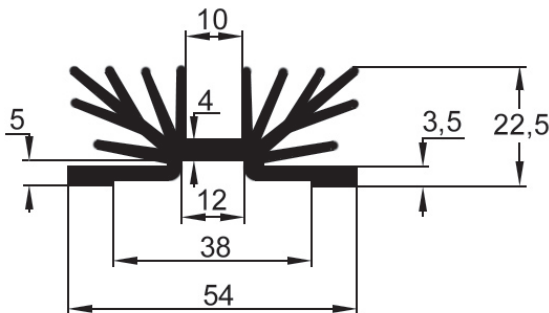

Bestellcode
 Ordercode

V 5224

Mounting
 accessories

Distance spacers

Fans

Freimaßtoleranz für Profile DIN1748, DIN17615 / Free dimensional tolerance for profiles DIN1748, DIN17615
 Freimaßtoleranz für die Bearbeitung DIN7168, mittel / Free dimensional tolerance for the handling DIN7168

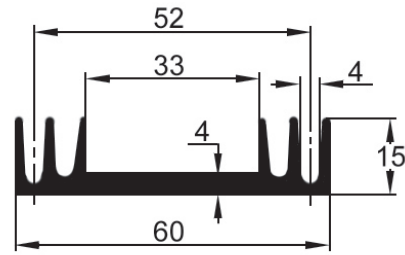
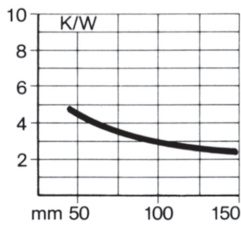

Bestellcode
 Ordercode

V 5331

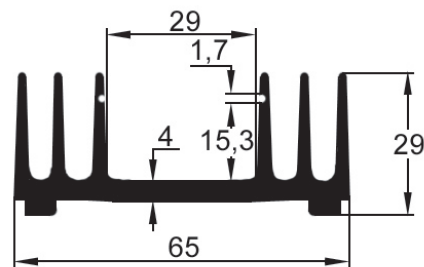
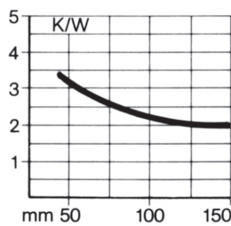

Bestellcode
 Ordercode

V 4429

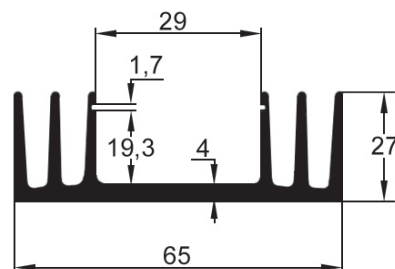
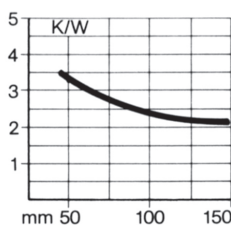

Bestellcode
 Ordercode

V 5428

Freimaßtoleranz für Profile DIN1748, DIN17615 / Free dimensional tolerance for profiles DIN1748, DIN17615
 Freimaßtoleranz für die Bearbeitung DIN7168, mittel / Free dimensional tolerance for the handling DIN7168

Finger-shaped

Attachable

Extruded
 with solderpins

Extruded
 standard length

Die-cast

Profiles

Mounting
 accessories

Distance spacers

Fans

Finger-shaped

Attachable

Extruded
with solderpins

Extruded
standard length

Die-cast

Profiles

Mounting
accessories

Distance spacers

Fans

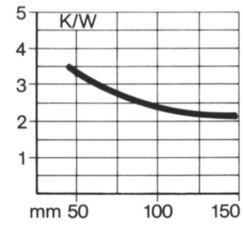
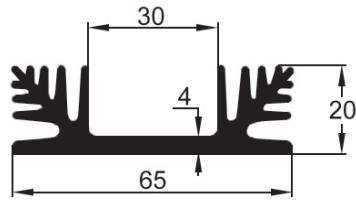

Bestellcode
Ordercode

V 5510

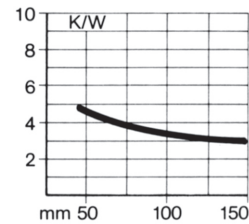
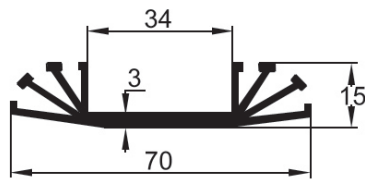

Bestellcode
Ordercode

V 4381

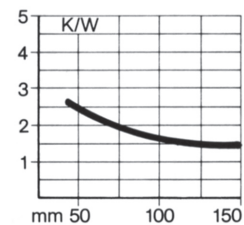
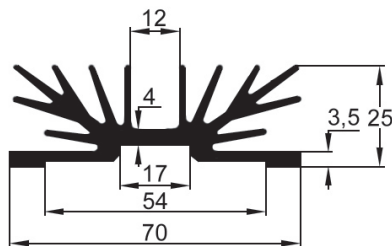

Bestellcode
Ordercode

V 5512

Freimaßtoleranz für Profile DIN1748, DIN17615 / Free dimensional tolerance for profiles DIN1748, DIN17615
 Freimaßtoleranz für die Bearbeitung DIN7168, mittel / Free dimensional tolerance for the handling DIN7168

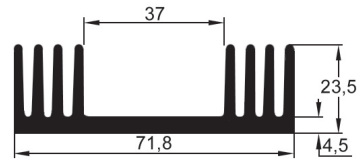
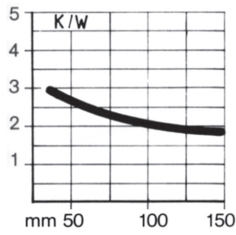

Bestellcode
 Ordercode

V 7480

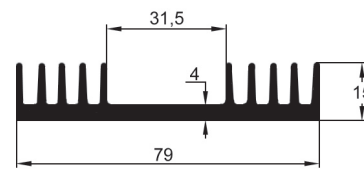
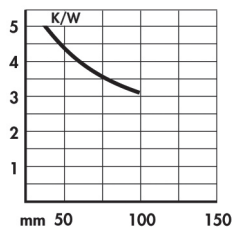

Bestellcode
 Ordercode

V 5517

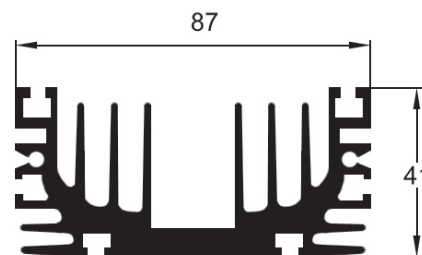
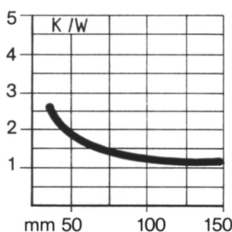

Bestellcode
 Ordercode

V 7260

Freimaßtoleranz für Profile DIN1748, DIN17615 / Free dimensional tolerance for profiles DIN1748, DIN17615
 Freimaßtoleranz für die Bearbeitung DIN7168, mittel / Free dimensional tolerance for the handling DIN7168

Finger-shaped

Attachable

Extruded with solderpins

Extruded standard length

Die-cast

Profiles

Mounting accessories

Distance spacers

Fans

Finger-shaped

Attachable

Extruded with solderpins

Extruded standard length

Die-cast

Profiles

Mounting accessories

Distance spacers

Fans

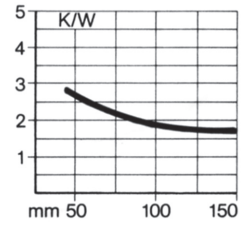
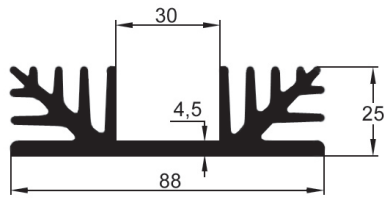

Bestellcode
 Ordercode

V 5511

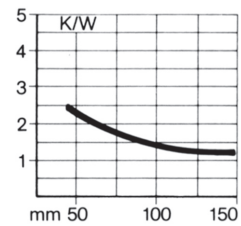
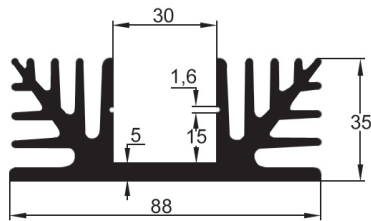

Bestellcode
 Ordercode

V 4511

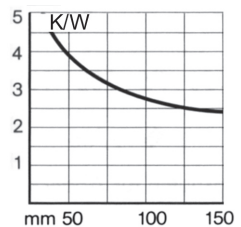
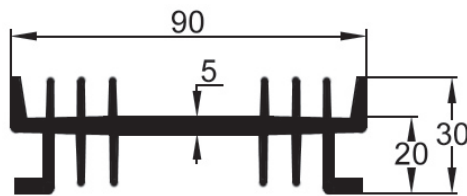

Bestellcode
 Ordercode

V 7172

Freimaßtoleranz für Profile DIN1748, DIN17615 / Free dimensional tolerance for profiles DIN1748, DIN17615
 Freimaßtoleranz für die Bearbeitung DIN7168, mittel / Free dimensional tolerance for the handling DIN7168

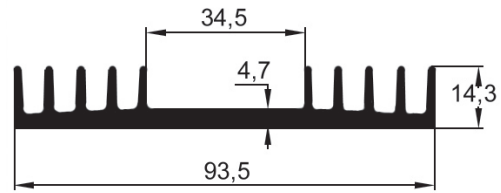
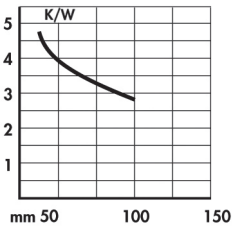

Bestellcode
 Ordercode

V 5302

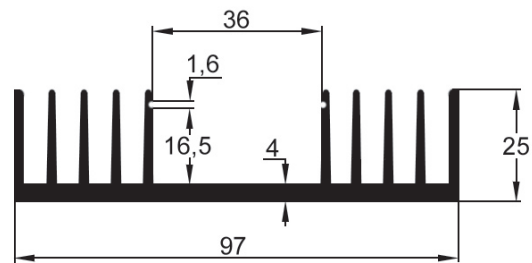
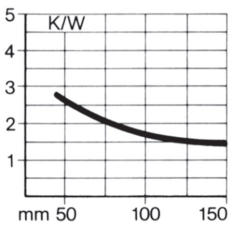

Bestellcode
 Ordercode

V 4432

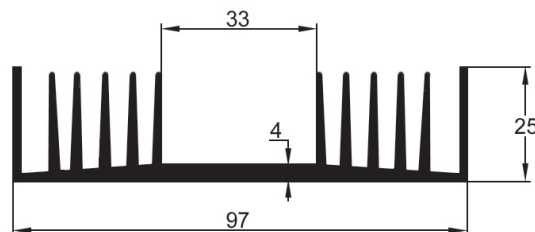
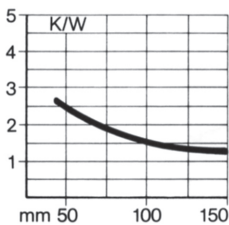

Bestellcode
 Ordercode

V 5481

Freimaßtoleranz für Profile DIN1748, DIN17615 / Free dimensional tolerance for profiles DIN1748, DIN17615
 Freimaßtoleranz für die Bearbeitung DIN7168, mittel / Free dimensional tolerance for the handling DIN7168

Finger-shaped

Attachable

Extruded
 with solderpins

Extruded
 standard length

Die-cast

Profiles

Mounting
 accessories

Distance spacers

Fans

Finger-shaped

Attachable

Extruded with solderpins

Extruded standard length

Die-cast

Profiles

Mounting accessories

Distance spacers

Fans

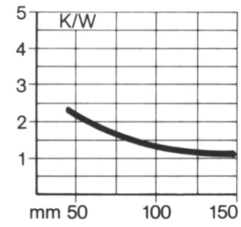
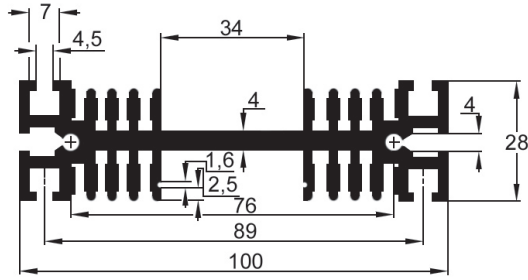

Bestellcode
Ordercode

V 5513

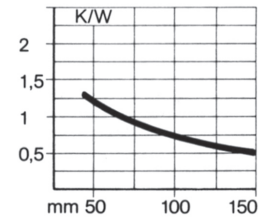
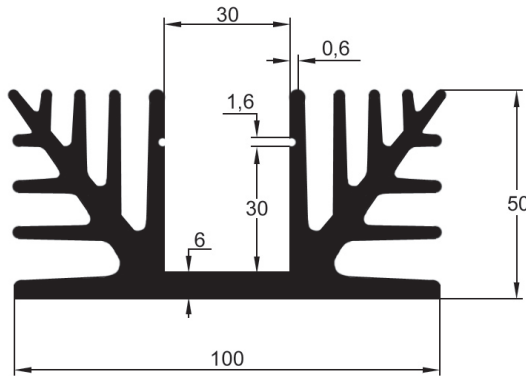

Bestellcode
Ordercode

V 6520

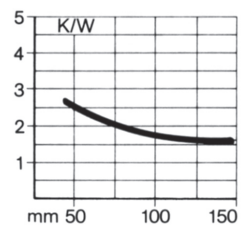
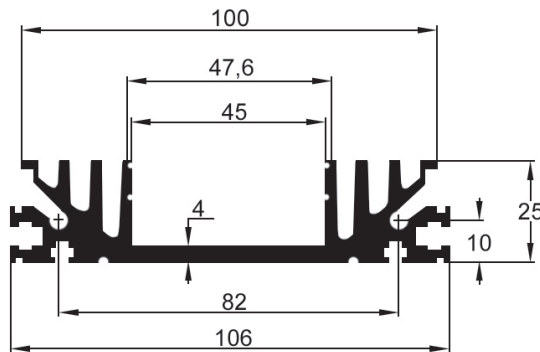

Bestellcode
Ordercode

V 5745

Freimaßtoleranz für Profile DIN1748, DIN17615 / Free dimensional tolerance for profiles DIN1748, DIN17615
Freimaßtoleranz für die Bearbeitung DIN7168, mittel / Free dimensional tolerance for the handling DIN7168

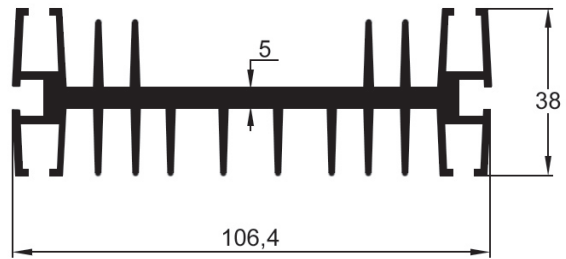
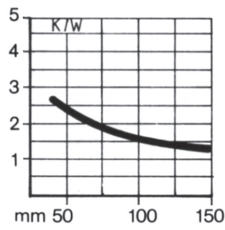

Bestellcode
 Ordercode

V 7749

Finger-shaped

Attachable

Extruded
 with solderpins

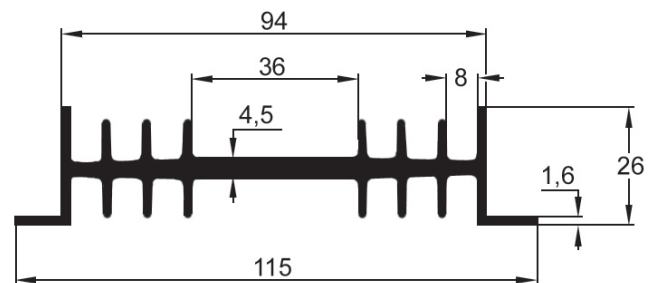
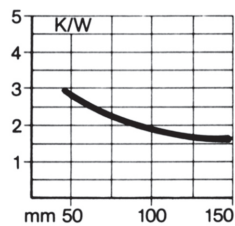

Bestellcode
 Ordercode

V 3940

Extruded
 standard length

Die-cast

Profiles

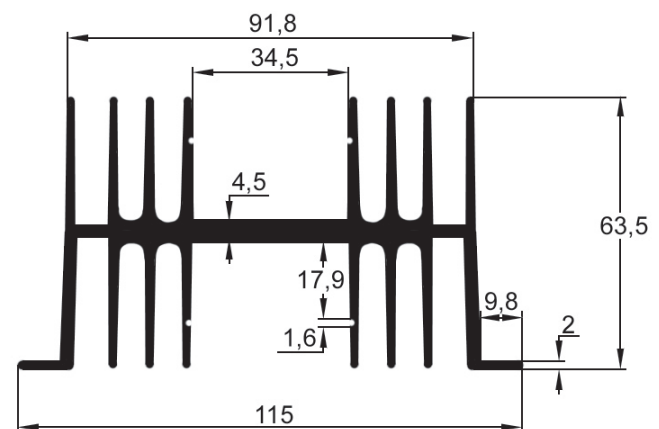
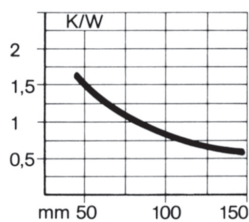

Bestellcode
 Ordercode

V 4365

Mounting
 accessories

Distance spacers

Fans

Freimaßtoleranz für Profile DIN1748, DIN17615 / Free dimensional tolerance for profiles DIN1748, DIN17615
 Freimaßtoleranz für die Bearbeitung DIN7168, mittel / Free dimensional tolerance for the handling DIN7168

Finger-shaped

Attachable

Extruded with solderpins

Extruded standard length

Die-cast

Profiles

Mounting accessories

Distance spacers

Fans

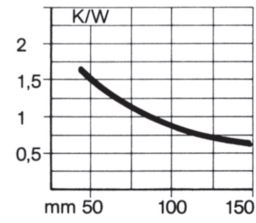
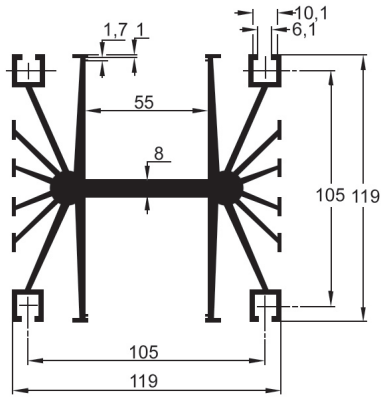

Bestellcode
Ordercode

V 5264

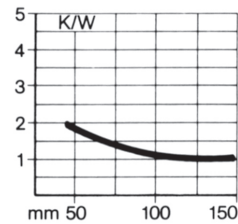
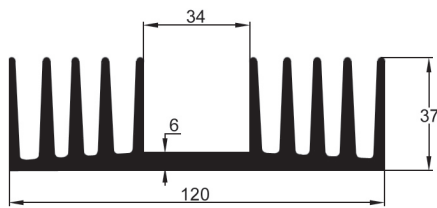

Bestellcode
Ordercode

V 5433

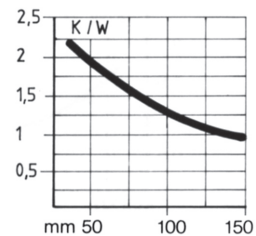
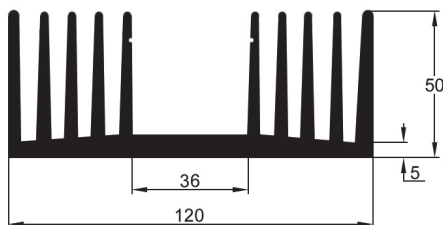

Bestellcode
Ordercode

V 7500

Freimaßtoleranz für Profile DIN1748, DIN17615 / Free dimensional tolerance for profiles DIN1748, DIN17615
Freimaßtoleranz für die Bearbeitung DIN7168, mittel / Free dimensional tolerance for the handling DIN7168

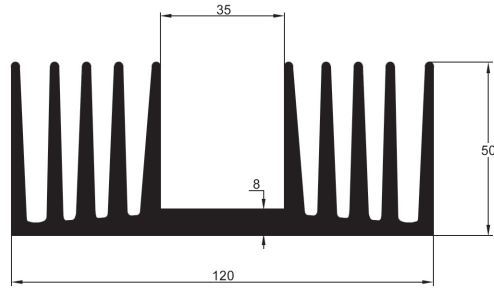
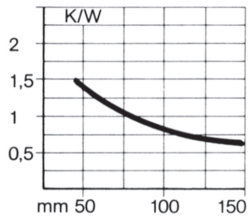

Bestellcode
 Ordercode

V 5434

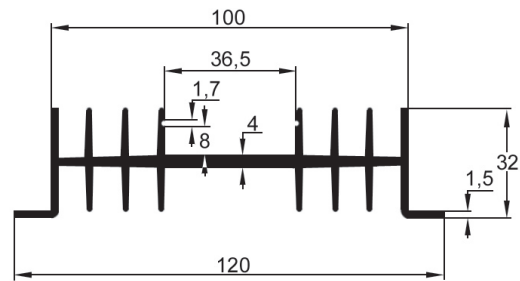
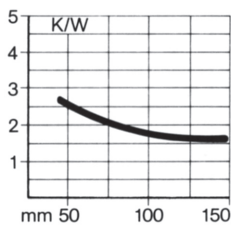

Bestellcode
 Ordercode

V 4329

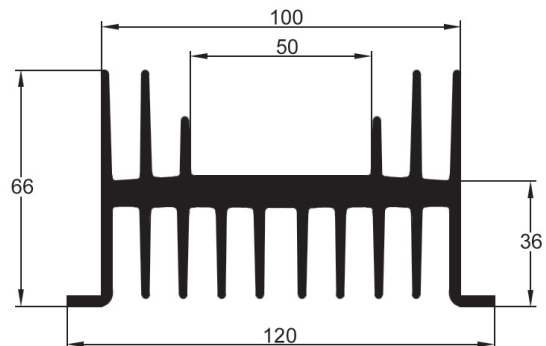
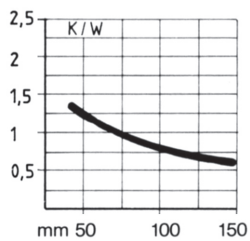

Bestellcode
 Ordercode

V 7454

Freimaßtoleranz für Profile DIN1748, DIN17615 / Free dimensional tolerance for profiles DIN1748, DIN17615
 Freimaßtoleranz für die Bearbeitung DIN7168, mittel / Free dimensional tolerance for the handling DIN7168

Finger-shaped

Attachable

Extruded
 with solderpins

Extruded
 standard length

Die-cast

Profiles

Mounting
 accessories

Distance spacers

Fans

Finger-shaped

Attachable

Extruded with solderpins

Extruded standard length

Die-cast

Profiles

Mounting accessories

Distance spacers

Fans

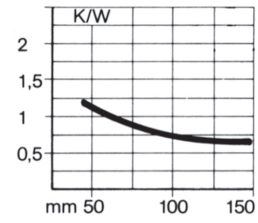
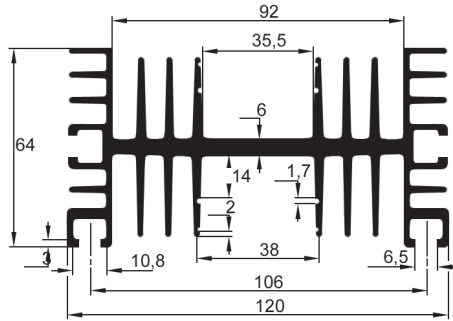

Bestellcode
Ordercode

V 5308

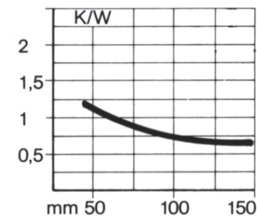
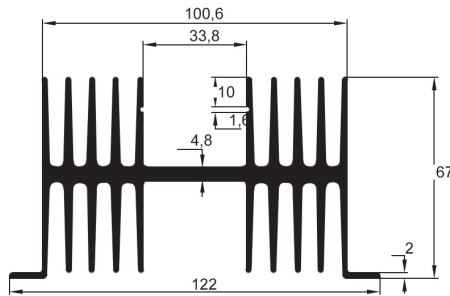

Bestellcode
Ordercode

V 5500

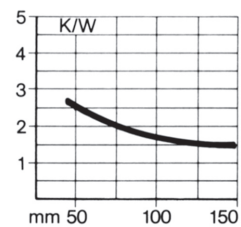
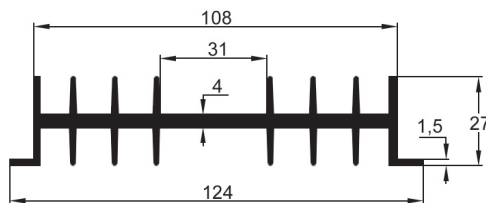

Bestellcode
Ordercode

V 4493

Freimaßtoleranz für Profile DIN1748, DIN17615 / Free dimensional tolerance for profiles DIN1748, DIN17615
Freimaßtoleranz für die Bearbeitung DIN7168, mittel / Free dimensional tolerance for the handling DIN7168

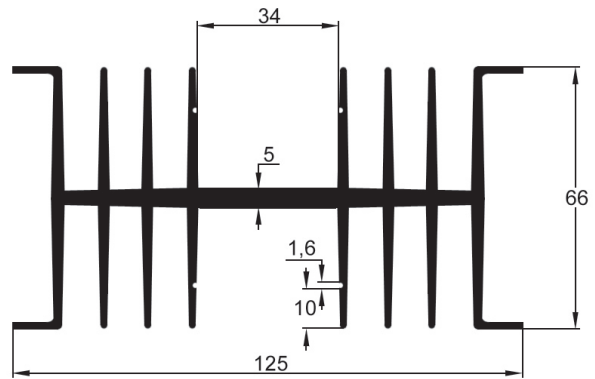
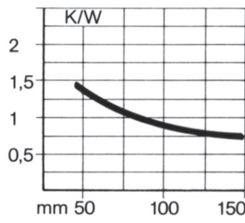

Bestellcode
 Ordercode

V 5501

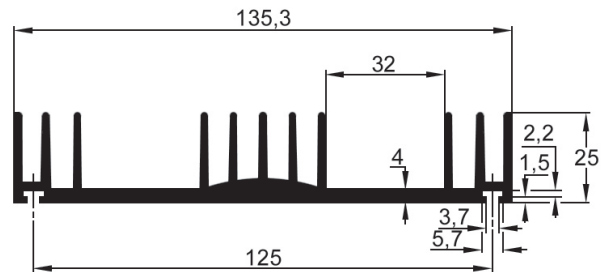
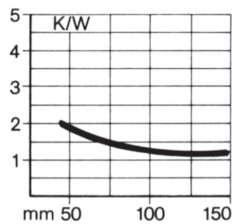

Bestellcode
 Ordercode

V 5390

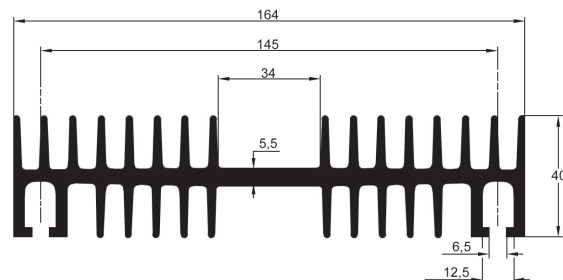
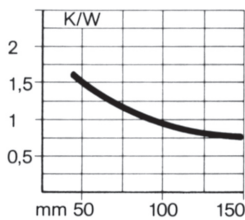

Bestellcode
 Ordercode

V 5373

Freimaßtoleranz für Profile DIN1748, DIN17615 / Free dimensional tolerance for profiles DIN1748, DIN17615
 Freimaßtoleranz für die Bearbeitung DIN7168, mittel / Free dimensional tolerance for the handling DIN7168

Finger-shaped

Attachable

Extruded
 with solderpins

Extruded
 standard length

Die-cast

Profiles

Mounting
 accessories

Distance spacers

Fans

Finger-shaped

Attachable

Extruded
with solderpins

Extruded
standard length

Die-cast

Profiles

Mounting
accessories

Distance spacers

Fans

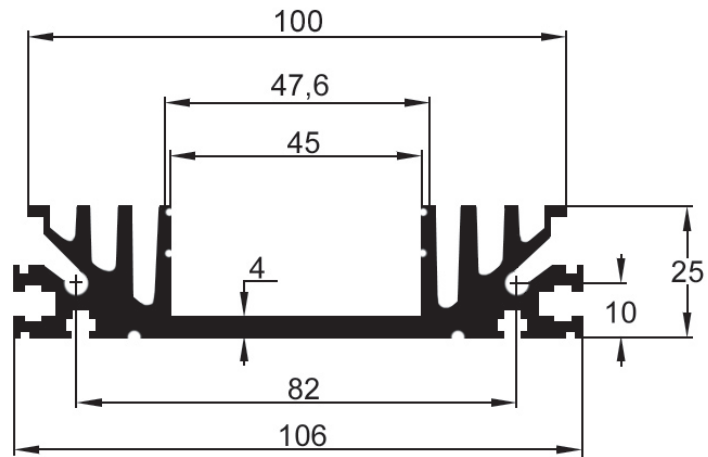

Bestellcode
Ordercode

V 5745

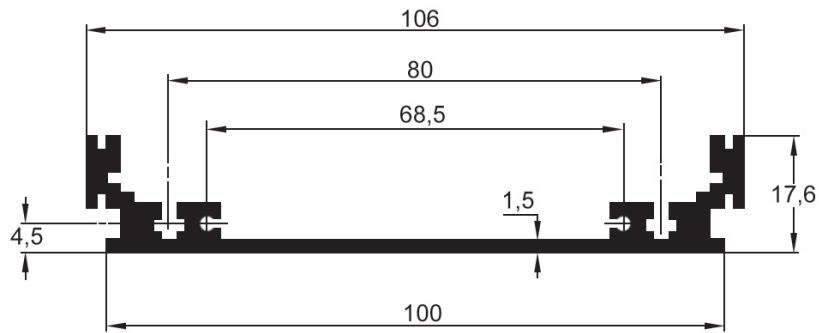

Bestellcode
Ordercode

V 5744

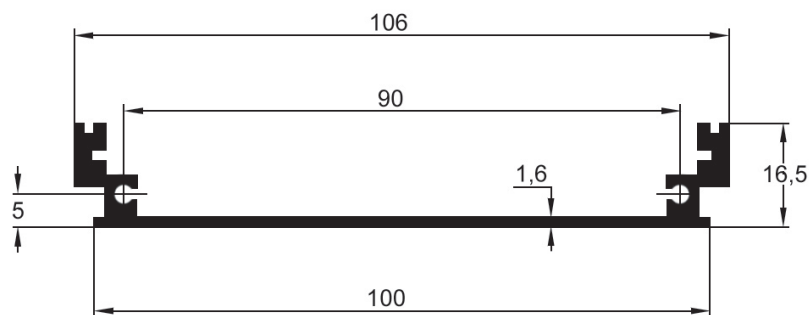

Bestellcode
Ordercode

V 6704

Freimaßtoleranz für Profile DIN1748, DIN17615 / Free dimensional tolerance for profiles DIN1748, DIN17615
Freimaßtoleranz für die Bearbeitung DIN7168, mittel / Free dimensional tolerance for the handling DIN7168

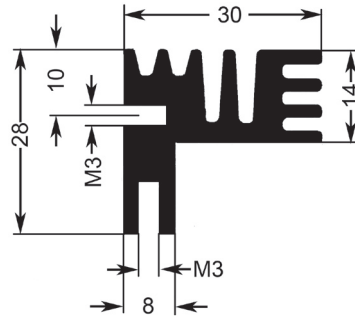
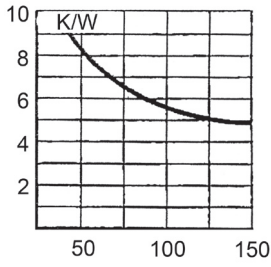

Bestellcode
 Ordercode

V 7982

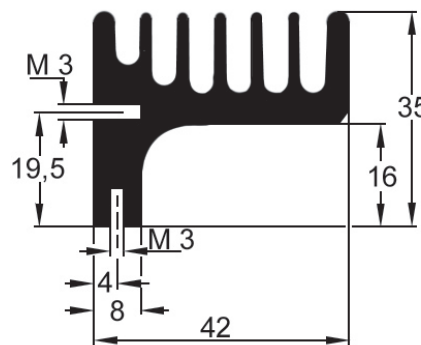
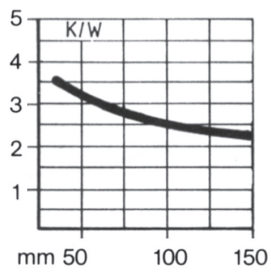

Bestellcode
 Ordercode

V 7702

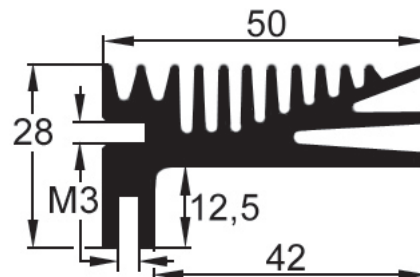
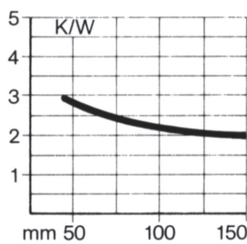

Bestellcode
 Ordercode

V 6716 Z

Freimaßtoleranz für Profile DIN1748, DIN17615 / Free dimensional tolerance for profiles DIN1748, DIN17615
 Freimaßtoleranz für die Bearbeitung DIN7168, mittel / Free dimensional tolerance for the handling DIN7168

Finger-shaped

Attachable

Extruded with solderpins

Extruded standard length

Die-cast

Profiles

Mounting accessories

Distance spacers

Fans

Finger-shaped

Attachable

Extruded with solderpins

Extruded standard length

Die-cast

Profiles

Mounting accessories

Distance spacers

Fans

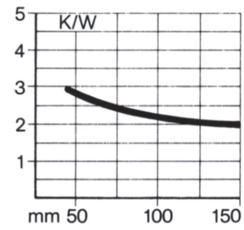
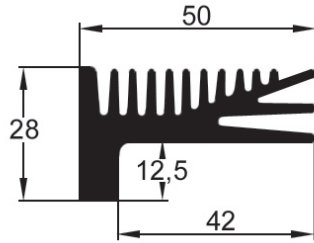

Bestellcode
Ordercode

V 6716

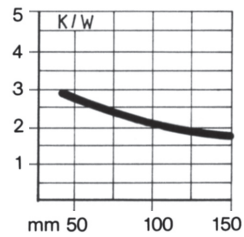
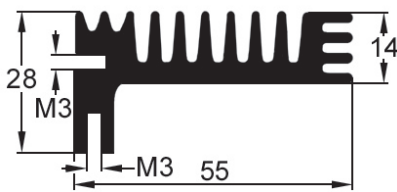

Bestellcode
Ordercode

V 7496

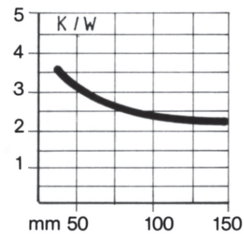
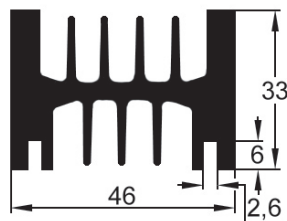

Bestellcode
Ordercode

V 7502

Freimaßtoleranz für Profile DIN1748, DIN17615 / Free dimensional tolerance for profiles DIN1748, DIN17615
Freimaßtoleranz für die Bearbeitung DIN7168, mittel / Free dimensional tolerance for the handling DIN7168

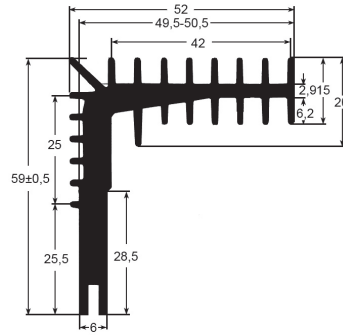
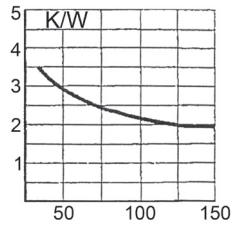

Bestellcode
 Ordercode

V 7980

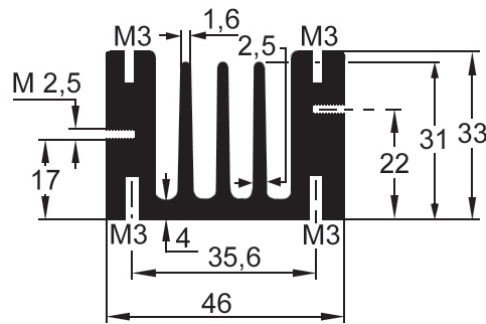
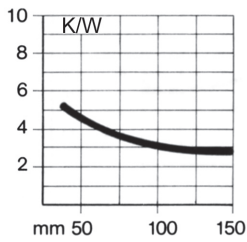

Bestellcode
 Ordercode

V 5583

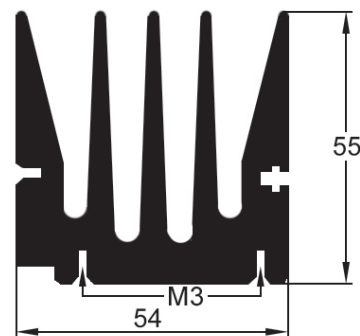
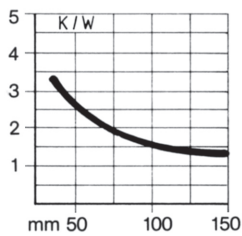

Bestellcode
 Ordercode

V 7660

Freimaßtoleranz für Profile DIN1748, DIN17615 / Free dimensional tolerance for profiles DIN1748, DIN17615
 Freimaßtoleranz für die Bearbeitung DIN7168, mittel / Free dimensional tolerance for the handling DIN7168

Finger-shaped

Attachable

Extruded with solderpins

Extruded standard length

Die-cast

Profiles

Mounting accessories

Distance spacers

Fans

Finger-shaped

Attachable

Extruded
with solderpins

Extruded
standard length

Die-cast

Profiles

Mounting
accessories

Distance spacers

Fans

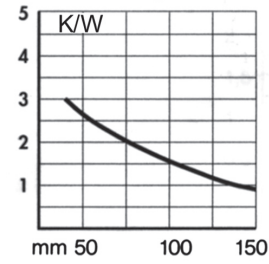
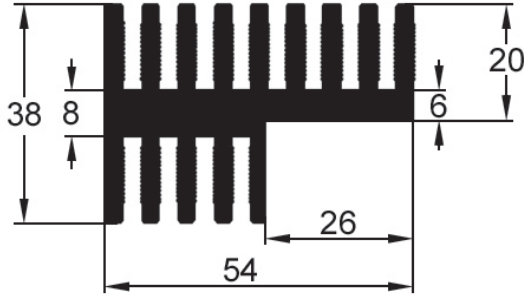

Bestellcode
Ordercode

V 7792

Bitte „x“ durch die geeignete Option ersetzen
Please replace „x“ appropriate option

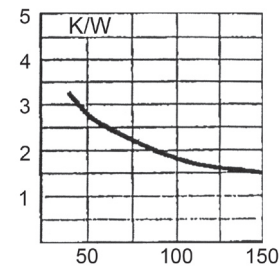
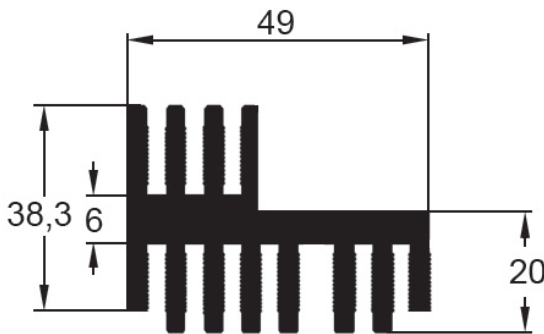

Bestellcode
Ordercode

V 7966

Bitte „x“ durch die geeignete Option ersetzen
Please replace „x“ appropriate option

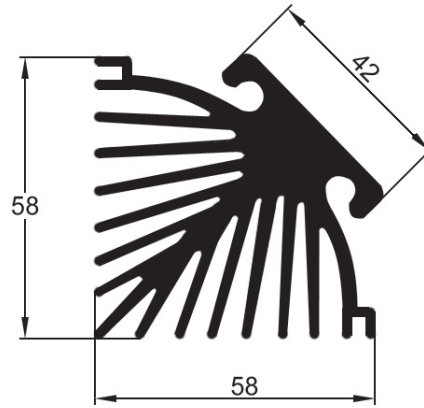

Bestellcode
Ordercode

V 4858

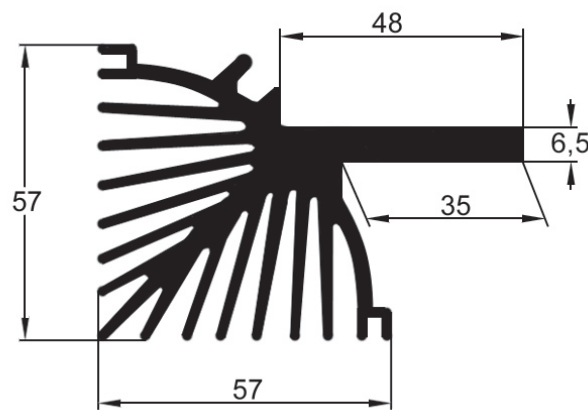

Bestellcode
Ordercode

V 4857

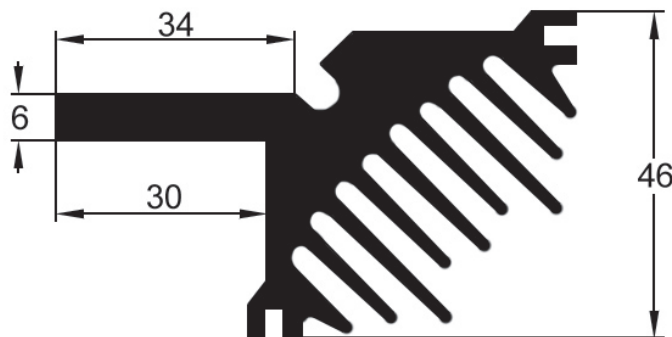

Bestellcode
Ordercode

V 4859

Freimaßtoleranz für Profile DIN1748, DIN17615 / Free dimensional tolerance for profiles DIN1748, DIN17615
Freimaßtoleranz für die Bearbeitung DIN7168, mittel / Free dimensional tolerance for the handling DIN7168

Finger-shaped

Attachable

Extruded
with solderpins

Extruded
standard length

Die-cast

Profiles

Mounting
accessories

Distance spacers

Fans

Finger-shaped

Attachable

Extruded
with solderpins

Extruded
standard length

Die-cast

Profiles

Mounting
accessories

Distance spacers

Fans

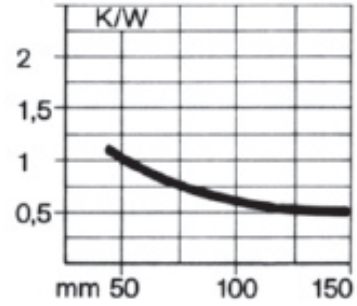
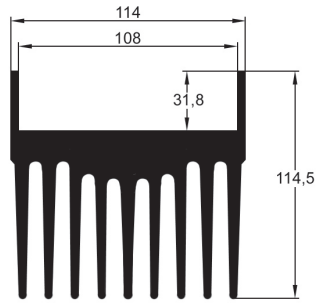

Bestellcode
Ordercode

V 5304

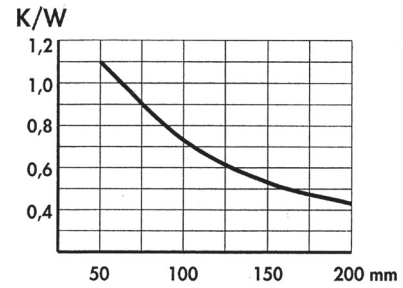
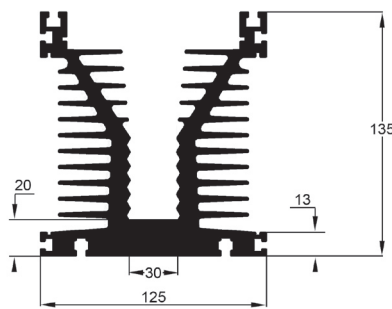

Bestellcode
Ordercode

V 9190

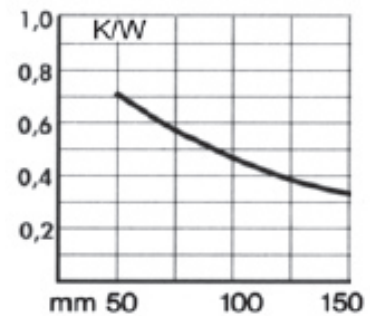
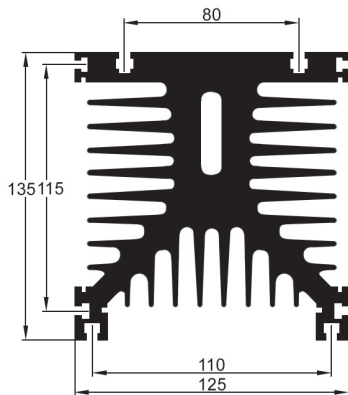

Bestellcode
Ordercode

V 6509

Freimaßtoleranz für Profile DIN1748, DIN17615 / Free dimensional tolerance for profiles DIN1748, DIN17615
Freimaßtoleranz für die Bearbeitung DIN7168, mittel / Free dimensional tolerance for the handling DIN7168

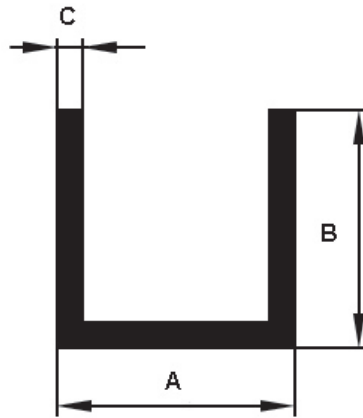

Beispiele
Examples

- A: 8 mm - 260 mm
 B: 8 mm - 80 mm auch ungleichschenkelig möglich also scalene possible
 C: 1 mm - 10 mm

Bestellcode
Ordercode

	A	B	C
V5252	25	25	2
V5333	30	30	3
V5474	34	32	2
V5251	29	15	2
V4874	12	15	2
V5616	17	13	1,5
V7268	20	20	2
V7969	15	30	4

Flach-, Winkel-, U-, T-, Z-Profile, sowie Rohre und Rundstangen auf Anfrage verfügbar.
 Nicht laufend bevorratet.
 Profile auf Wunsch nach Zeichnung bearbeitet.

Flat-, angle-, U-, T-, Z-profiles, as well as pipes and round rods available.
 Not constantly provided on stock.
 Profiles machined according to your drawings.

Freimaßtoleranz für Profile DIN1748, DIN17615 / Free dimensional tolerance for profiles DIN1748, DIN17615
 Freimaßtoleranz für die Bearbeitung DIN7168, mittel / Free dimensional tolerance for the handling DIN7168

Finger-shaped
 Attachable
 Extruded with solderpins
 Extruded standard length
 Die-cast
 Profiles
 Mounting accessories
 Distance spacers
 Fans

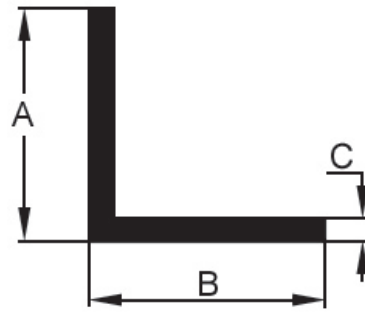

Beispiele Examples

- A: 10 mm - 250 mm
B: 10 mm - 100 mm
C: 2 mm - 10 mm

Bestellcode Ordercode

	A	B	C
V7716	20	20	2
V7717	25	25	3
V7648	30	30	4
V7332	50	50	2
V7434	100	20	2

Flach-, Winkel-, U-, T-, Z-Profile, sowie Rohre und Rundstangen auf Anfrage verfügbar.
Nicht laufend bevorratet.

Profile auf Wunsch nach Zeichnung bearbeitet.

Flat-, angle-, U-, T-, Z-profiles, as well as pipes and round rods available.

Not constantly provided on stock.

Profiles machined according to your drawings.

Freimaßtoleranz für Profile DIN1748, DIN17615 / Free dimensional tolerance for profiles DIN1748, DIN17615
Freimaßtoleranz für die Bearbeitung DIN1768, mittel / Free dimensional tolerance for the handling DIN1768

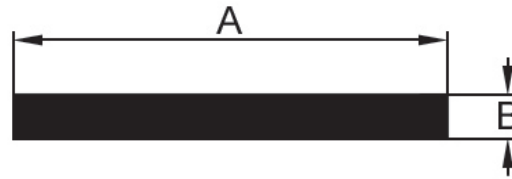

Beispiele
Examples

A: 6 mm - 300 mm
B: 2 mm - 40 mm

Bestellcode
Ordercode

	A	B
V7550	15	5
V7570	15	10
V7527	20	5
V7414	20	6
V7563	20	10
V7805	20	25
V7622	25	10
V7516	25	25
V7925	30	3
V7383	30	10

	A	B
V7775	32	5
V7624	32	32
V7565	40	5
V7916	40	30
V6705	50	10
V7462	60	10
V7715	100	3
V7457	143	5
V7592	228	10

Flach-, Winkel-, U-, T-, Z-Profile, sowie Rohre und Rundstangen auf Anfrage verfügbar.
Nicht laufend bevorratet.

Profile auf Wunsch nach Zeichnung bearbeitet.

Flat-, angle-, U-, T-, Z-profiles, as well as pipes and round rods available.

Not constantly provided on stock.

Profiles machined according to your drawings.

Freimaßtoleranz für Profile DIN1748, DIN17615 / Free dimensional tolerance for profiles DIN1748, DIN17615
Freimaßtoleranz für die Bearbeitung DIN7168, mittel / Free dimensional tolerance for the handling DIN7168

Finger-shaped

Attachable

Extruded
with solderpins

Extruded
standard length

Die-cast

Profiles

Mounting
accessories

Distance spacers

Fans