

3-phase Filters FN 3120

High-end EMC/RFI Filter for Conventional and Regenerative Drives

SCHAFFNER
energy efficiency and reliability



- High-performance filter for extremely noisy applications
- Ideal for the latest regenerative drives (with additional line impedance)
- Significantly improves the reliability and immunity of installations
- Enables compliance with Class B limits even with very long cables

Approvals



Technical specifications

Maximum continuous operating voltage:	3x 520/300VAC (480VAC +10% possible)
Operating frequency:	dc to 60Hz
Rated currents:	25 to 230A @ 50°C
High potential test voltage:	P → E 2750VDC for 2 sec P → P 2250VDC for 2 sec
Protection category:	IP20
Overload capability:	4x rated current at switch on, 1.5x rated current for 1 minute, once per hour
Temperature range (operation and storage):	-25°C to +100°C (25/100/21)
Flammability corresponding to:	UL 94V-2 or better
Design corresponding to:	UL 1283, CSA 22.2 No. 8 1986, IEC/EN 60939
MTBF @ 50°C/400V (Mil-HB-217F):	>300,000 hours

Features and benefits

- High-performance filter for mainly industrial motor drive applications with extremely high noise levels, providing sufficient interference suppression to achieve Class B even with very long motor cables (e.g. machine tools with up to 12 axes with ~10 to 20m cables each).
- Broadband attenuation performance and exceptional saturating resistance ensure reliable interference suppression also in applications with regenerative drives (with an additional line impedance).
- FN 3120 operated on the mains input of machines or equipment contributes significantly to the reliability and immunity by offering protection against conducted interference phenomena coming from the environment.
- Solid, touch-safe terminal blocks offer sufficient contacting cross section according to the EN 60204-1 installation standard, which is very common for industrial equipment like machine tools.
- Compact dimensions and light weight design with good accessibility for automatic and hand tools guarantee a simple time and space-saving installation.

Typical electrical schematic

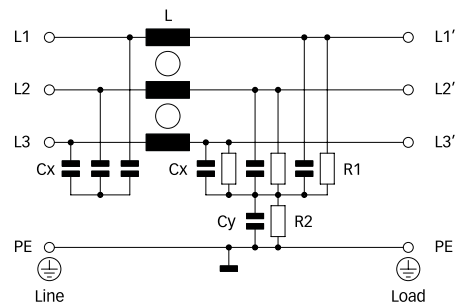

Typical applications

Mainly industrial equipment, machinery and machine tools such as printing machines, packaging machines, extruders, wood working machines, milling and drilling machines, laser cutting machines, welding machines, robotics, conveyors, assembly lines, pumps, oil production, chemical and mining industry, etc. The filters are ideal for most motor drive applications and particularly for regenerative drives.

Filter selection table

Filter	Rated current @ 50°C (40°C)	Typical drive power rating*	Leakage current** @ 480VAC/50Hz	Power loss @ 25°C/50Hz	Input/Output connections	Weight
	[A]	[kW]	[mA]	[W]		[kg]
FN 3120H-25-33	25 (27)	15	97.9	17.1	-33	2.4
FN 3120H-50-53	50 (54)	30	97.9	17.5	-53	2.7
FN 3120H-80-35	80 (87)	45	97.9	25.9	-35	5.0
FN 3120H-110-35	110 (120)	55	97.9	25.4	-35	6.1
FN 3120H-150-40	150 (164)	75	97.9	40.5	-40	6.3
FN 3120H-230-40	230 (230)	132	97.9	33.5	-40	13.3

* Calculated at rated current, 480VAC and cos phi = 0.8. The exact value depends upon the efficiency of the drive, the motor and the entire application.

** Maximum leakage under normal operating conditions. Note: if two phases are interrupted, worst case leakage could reach 5.4 times higher levels.

Typical filter attenuation

Per CISPR 17; A = 50Ω/50Ω sym; B = 50Ω/50Ω asym; C = 0.1Ω/100Ω sym; D = 100Ω/0.1Ω sym

25A types

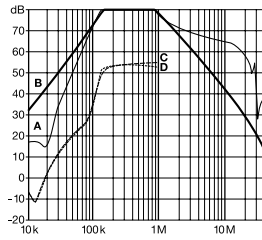

50 to 110A types

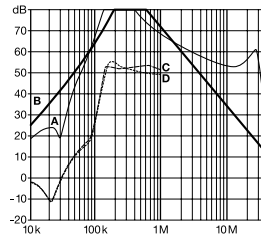

150A types

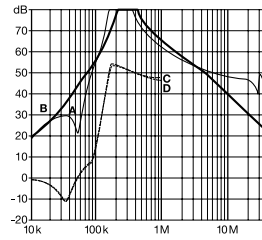

230A types

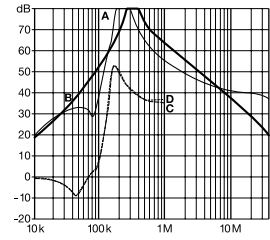

Mechanical data

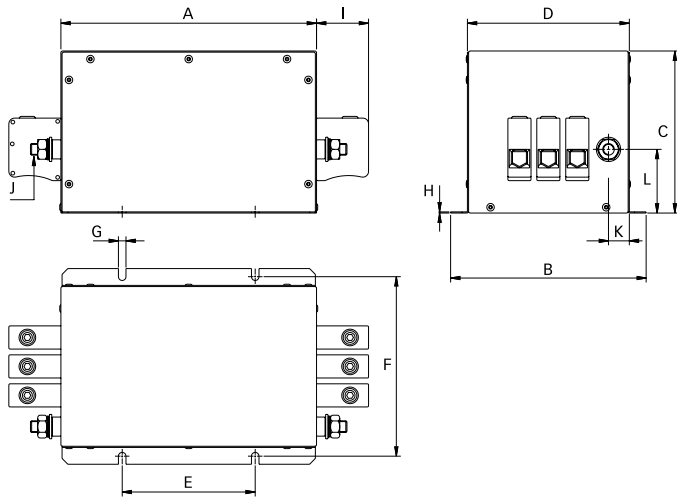

Dimensions

	25A	50A	80A	110A	150A	230A
A	214	214	221	221	221	300
B	159	159	169	169	169	168
C	64	64	140	140	140	140
D	129	129	140	140	140	140
E	115	115	115	115	115	165 (82.5/82.5)*
F	145	145	155	155	155	155
G	6.5	6.5	6.5	6.5	6.5	6.5
H	1	1	1	1	1	1
I	25	29.45	45	45	51	51
J	M5	M6	M10	M10	M10	M10
K	21.5	24.5	18	18	13	13
L	26	35	55	55	62	62

* 230A filters provide 2 additional mounting slots, to do justice to the additional product weight. They are located right in the center of those mounting slots shown in the drawing above (82.5/82.5 -> 165mm).

All dimensions in mm; 1 inch = 25.4mm

Tolerances according: ISO 2768-m / EN 22768-m

Filter input/output connector cross sections

	-33	-35	-40	-53
Solid wire	16mm ²	50mm ²	95mm ²	25mm ²
Flex wire	10mm ²	50mm ²	95mm ²	16mm ²
AWG type wire	AWG 6	AWG 1/0	AWG 4/0	AWG 4
Recommended torque	1.5 - 1.8Nm	7 - 8Nm	17 - 20Nm	2.0 - 2.3Nm

Please visit www.schaffner.com to find more details on filter connectors.

**Headquarters and
global innovation and
development center**

Schaffner Group
Nordstrasse 11
4542 Luterbach
Switzerland
T +41 32 681 66 26
F +41 32 681 66 30
info@schaffner.ch
www.schaffner.com

Sales and application centers

China
Schaffner EMC Ltd. Shanghai
Building 11, Lane 1365
East Kangqiao Road
Shanghai 201319
T +86 21 6813 9855
F +86 21 6813 9811
cschina@schaffner.com
www.schaffner.com

Germany
Schaffner Deutschland GmbH
Schoemperlenstrasse 12B
76185 Karlsruhe
T +49 721 56910
F +49 721 569110
germanysales@schaffner.com

Finland
Schaffner Oy
Tynninkuja 7
08700 Lohja
T +358 19 35 72 71
F +358 19 32 66 10
finlandsales@schaffner.com

France
Schaffner EMC S.A.S.
112, Quai de Bezons
95103 Argenteuil
T +33 1 34 34 30 60
F +33 1 39 47 02 28
francesales@schaffner.com

Italy
Schaffner EMC S.r.l.
Via Galileo Galilei, 47
20092 Cinisello Balsamo (MI)
T +39 02 66 04 30 45/47
F +39 02 61 23 943
italysales@schaffner.com

Japan
Schaffner EMC K.K.
Mitsui-Seimei Sangenjaya Bldg. 7F
1-32-12, Kamiyama, Setagaya-ku
Tokyo 154-0011
T +81 3 5712 3650
F +81 3 5712 3651
japansales@schaffner.com
www.schaffner.jp

Sweden
Schaffner EMC AB
Turebergstorg 1, 6
19147 Sollentuna
T +46 8 5792 1121/22
F +46 8 92 96 90
swedensales@schaffner.com

Switzerland
Schaffner EMV AG
Nordstrasse 11
4542 Luterbach
T +41 32 681 66 26
F +41 32 681 66 41
sales@schaffner.ch

Singapore
Schaffner EMC Pte Ltd.
Blk 3015A Ubi Road 1
05-09 Kampong Ubi Industrial
Estate
T +65 6377 3283
F +65 6377 3281
singaporesales@schaffner.com

Spain
Schaffner EMC España
Calle Caléndula 93,
Miniparc III, Edificio E
El Soto de la Moraleja,
Alcobendas
28109 Madrid
T +34 618 176 133
spainsales@schaffner.com

Taiwan
Schaffner EMV Ltd.
6th Floor, No 413
Rui Guang Road
Neihu District
Taipei City 114
T +886 2 87525050
F +886 2 87518086
taiwansales@schaffner.com

Thailand
Schaffner EMC Co. Ltd.
Northern Region Industrial Estate
67 Moo 4 Tambon Ban Klang
Amphur Muang P.O. Box 14
Lamphun 51000
T +66 53 58 11 04
F +66 53 58 10 19
thailsales@schaffner.com

UK
Schaffner Ltd.
5 Ashville Way
Molly Millars Lane
Wokingham
Berkshire RG41 2PL
T +44 118 9770070
F +44 118 9792969
uksales@schaffner.com
www.schaffner.uk.com

USA
Schaffner EMC Inc.
52 Mayfield Avenue
Edison, New Jersey 08837
T +1 732 225 9533
F +1 732 225 4789
usasales@schaffner.com
www.schaffner.com/us

To find your local partner within
Schaffner's global network, please go to

www.schaffner.com

May 2011

© 2011 Schaffner EMC.
Specifications subject to change without
notice. All trademarks recognized.

Schaffner is an ISO-registered company.
Its products are designed and manufac-
tured under the strict quality and environ-
mental requirements of the ISO 9001 and
ISO 14001 standards.

This document has been carefully
checked. However, Schaffner does not
assume any liability for errors or inac-
curacies.