

Photoconductive Series

Planar Diffused Silicon Photodiodes

The Photoconductive Detector Series are suitable for high speed and high sensitivity applications. The spectral range extends from 350 to 1100 nm, making these photodiodes ideal for visible and near IR applications, including such AC applications as detection of pulsed LASER sources, LEDs, or chopped light.

To achieve high speeds, these detectors should be reverse biased. Typical response times from 10 ns to 250 ns can be achieved with a 10V reverse bias, for example. When a reverse bias is applied, capacitance decreases (as seen in the figure below) corresponding directly to an increase in speed.

As indicated in the specification table, the reverse bias should not exceed 30 volts. Higher bias voltages will result in permanent damage to the detector.

Since a reverse bias generates additional dark current, the noise in the device will also increase with applied bias. For lower noise detectors, the Photovoltaic Series should be considered.

Refer to the Photoconductive Mode (PC) paragraph in the "Photodiode Characteristics" section of this catalog for detailed information on electronics set up.



APPLICATIONS

- Pulse Detectors
- Optical Communications
- Bar Code Readers
- Optical Remote Control
- Medical Equipment
- High Speed Photometry

FEATURES

- High Speed Response
- Low Capacitance
- Low Dark Current
- Wide Dynamic Range
- High Responsivity

Typical Capacitance vs. Reverse Bias

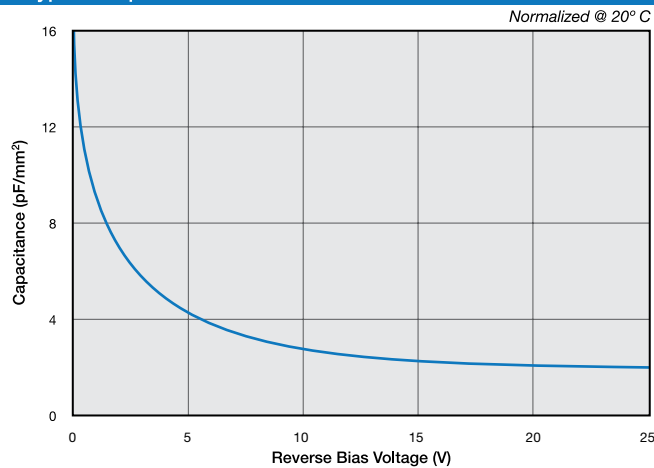

Typical Spectral Response

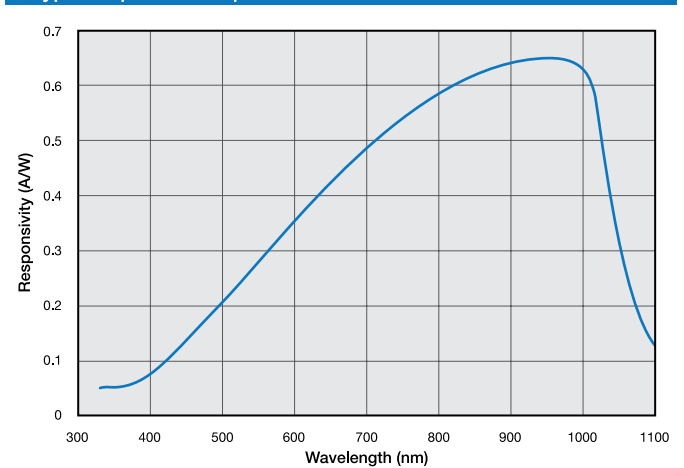

Typical Dark Current vs. Temperature

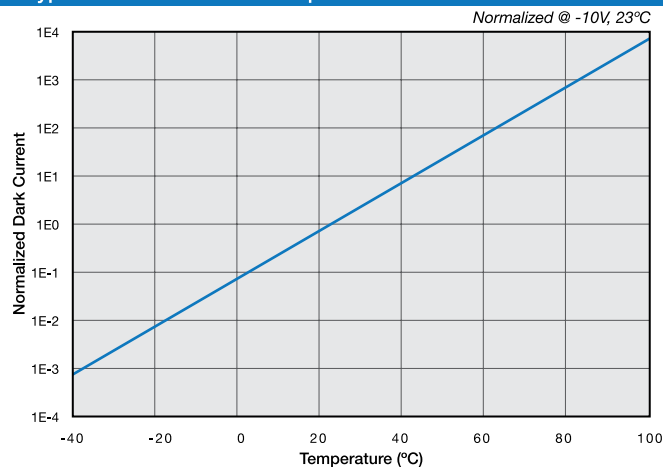

Typical Dark Current vs. Reverse Bias

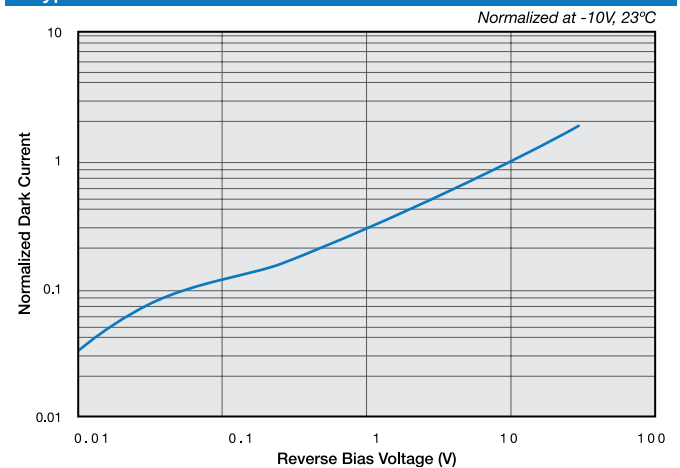

Photoconductive Series

Typical Electro-Optical Specifications at T_A=23°C

Model Number	Active Area		Peak Responsivity Wavelength	Responsivity at λ _p		Capacitance (pF)		Dark Current (nA)		NEP (W/√Hz)	Reverse Voltage (V)	Rise Time (ns)	Temp.* Range (°C)		Package Style ¶
	Area (mm ²)	Dimensions (mm)		λ _p (nm)	(A/W)		0 V	-10 V	-10 V				-10V 632nm 50 Ω	Operating	
			typ.		min.	typ.	typ.	typ.	typ.	max.	typ.	max.	typ.		
'D' Series, Metal Package															
PIN-020A	0.20	0.51 φ	970	0.60	0.65	4	1	0.01	0.15	2.8 e-15	30	6	-40 ~ +100	-55 ~ +125	1 / TO-18
PIN-040A	0.81	1.02 φ				8	2	0.05	0.50	6.2 e-15		8			
PIN-2DI ‡	1.1	0.81 x 1.37				25	5	0.10	1.0	8.7 e-15		10			4 / TO-18
PIN-3CDI	3.2	1.27 x 2.54				45	12	0.15	2	1.1 e-14		12			7 / TO-18
PIN-3CD						85	15	0.25	3	1.4 e-14					2 / TO-5
PIN-5DI	5.1	2.54 φ				225	40	0.35	6	1.6 e-14		14			2 / TO-5
PIN-5D															5 / TO-5
PIN-13DI	13	3.6 sq				330	60	0.5	10	1.9 e-14		17			2 / TO-5
PIN-13D															5 / TO-5
PIN-6DI	16.4	4.57 φ				700	130	1	15	2.8 e-14		24			3 / TO-8
PIN-6D															6 / TO-8
PIN-44DI	44	6.6 sq				1500	300	2	25	3.9 e-14		43			3 / TO-8
PIN-44D															6 / TO-8
PIN-10DI	100	11.28 φ				9500	1800	15	1000	1.1 e-13		250			10 / Lo-Prof
PIN-10D			11 / BNC												
PIN-25D	613	27.9 φ							12 / BNC						
'O' Series, Metal Package															
OSD1-0	1	1.0 sq	900	0.47	0.54	12	3	1	3	4.5 e-14	50	10	-25 ~ +75	-40 ~ +100	7 / TO-18
OSD5-0	5	2.5 φ				50	8	5	10	1.0 e-13		8			5 / TO-5
OSD15-0	15	3.8 sq				150	20	8	15	1.3 e-13		9			5 / TO-5
OSD35-0	35	5.9 sq				350	46	12	30	1.6 e-13		12			3 / TO-8
OSD60-0	58	7.6 sq				600	75	15	50	1.7 e-13		14			72 / TO-8
OSD100-0A	100	11.3 φ				1000	130	30	70	2.5 e-13		19			74 / Special
'D' Series, Plastic Package §															
FIL-5C	5.1	2.54 φ	970	0.60	0.65	85	15	0.25	3	1.4 e-14	30	12	-10 ~ +60	-20 ~ +70	14 / Plastic
FIL-20C	16.4	4.57 φ				330	60	0.5	10	1.9 e-14		17			
FIL-44C	44	6.6 sq				700	130	1	15	2.8 e-14		24			15 / Plastic
FIL-100C	100	11.28 φ				1500	300	2	25	3.9 e-14		43			
PIN-220D	200	10 x 20				3200	600	5	100	6.2 e-14		75			27 / Plastic

‡ The 'I' suffix on the model number is indicative of the photodiode chip being isolated from the package by an additional pin connected to the case.

§ The photodiode chips in "FIL" series are isolated in a low profile plastic package. They have a large field of view as well as "in line" pins.

¶ For mechanical drawings please refer to pages 58 thru 69.

* Non-condensing temperature and storage range, Non-condensing environment.

1. Parameter Definitions:

A = Distance from top of chip to top of glass.

a = Photodiode Anode.

B = Distance from top of glass to bottom of case.

c = Photodiode Cathode

(Note: cathode is common to case in metal package products unless otherwise noted).

W = Window Diameter.

F.O.V. = Field of View (see definition below).

2. Dimensions are in inches (1 inch = 25.4 mm).

3. Pin diameters are 0.018 ± 0.002" unless otherwise specified.

4. Tolerances (unless otherwise noted)

General: 0.XX ±0.01"

0.XXX ±0.005"

Chip Centering: ±0.010"

Dimension 'A': ±0.015"

5. Windows

All '**UV**' Enhanced products are provided with QUARTZ glass windows, 0.027 ± 0.002" thick.

All '**XUV**' products are provided with removable windows.

All '**DLS**' PSD products are provided with A/R coated glass windows.

All '**FIL**' photoconductive and photovoltaic products are epoxy filled instead of glass windows.

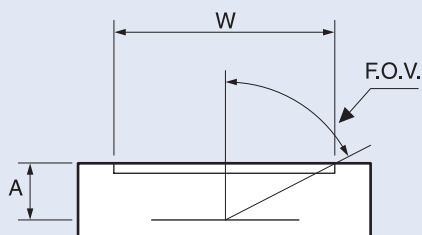

$$F.O.V. = \tan^{-1} \left(\frac{W}{2A} \right)$$



For Further Assistance
Please Call One of Our Experienced
Sales and Applications Engineers

310-978-0516



- Or -
On the Internet at

www.osioptoelectronics.com

Mechanical Specifications

All units in inches. Pinouts are bottom view.

1 TO-18	2 TO-5	3 TO-8																																		
<p>Products:</p> <p>PIN-020A PIN-040A PIN-040-DP/SB</p> <p>Pin Circle Dia.=0.100</p> <table border="1"> <thead> <tr> <th>P/N</th> <th>A</th> <th>B</th> <th>W</th> </tr> </thead> <tbody> <tr> <td>PIN-020A</td> <td>0.075</td> <td>0.200</td> <td>0.155</td> </tr> <tr> <td>PIN-040A</td> <td>0.075</td> <td>0.200</td> <td>0.155</td> </tr> </tbody> </table>	P/N	A	B	W	PIN-020A	0.075	0.200	0.155	PIN-040A	0.075	0.200	0.155	<p>Products:</p> <p>PIN-5DI PIN-5DPI PIN-13DI PIN-13DPI PIN-5-YAG CD-25T</p> <p>Pin Circle Dia.=0.200</p> <table border="1"> <thead> <tr> <th>P/N</th> <th>A</th> <th>B</th> <th>W</th> </tr> </thead> <tbody> <tr> <td>All Others</td> <td>0.094</td> <td>0.180</td> <td>0.240</td> </tr> <tr> <td>CD-25T</td> <td>0.050</td> <td>0.130</td> <td>0.23</td> </tr> </tbody> </table>	P/N	A	B	W	All Others	0.094	0.180	0.240	CD-25T	0.050	0.130	0.23	<p>Products:</p> <p>PIN-6DI PIN-6DPI PIN-44DI PIN-44DPI OSD35-0 OSD35-7Q</p> <p>Pin Circle Dia.=0.295</p> <table border="1"> <thead> <tr> <th>P/N</th> <th>A</th> </tr> </thead> <tbody> <tr> <td>PIN-6DI/6DPI</td> <td>0.115</td> </tr> <tr> <td>PIN-44DI/44DPI</td> <td>0.125</td> </tr> <tr> <td>OSD35-0</td> <td>0.130</td> </tr> <tr> <td>OSD35-7Q</td> <td>0.130 Quartz Window</td> </tr> </tbody> </table>	P/N	A	PIN-6DI/6DPI	0.115	PIN-44DI/44DPI	0.125	OSD35-0	0.130	OSD35-7Q	0.130 Quartz Window
P/N	A	B	W																																	
PIN-020A	0.075	0.200	0.155																																	
PIN-040A	0.075	0.200	0.155																																	
P/N	A	B	W																																	
All Others	0.094	0.180	0.240																																	
CD-25T	0.050	0.130	0.23																																	
P/N	A																																			
PIN-6DI/6DPI	0.115																																			
PIN-44DI/44DPI	0.125																																			
OSD35-0	0.130																																			
OSD35-7Q	0.130 Quartz Window																																			
<p>Products:</p> <p>PIN-2DI PIN-2DPI PIN-3CDP PIN-3CDPI BPX-65R</p> <p>Pin Circle Dia.=0.100</p> <table border="1"> <thead> <tr> <th>P/N</th> <th>A</th> <th>B</th> </tr> </thead> <tbody> <tr> <td>BPX-65R</td> <td>0.070</td> <td>0.200</td> </tr> <tr> <td>All Others</td> <td>0.090</td> <td>0.150</td> </tr> </tbody> </table>	P/N	A	B	BPX-65R	0.070	0.200	All Others	0.090	0.150	<p>Products:</p> <p>PIN-5D PIN-5DP PIN-5DP/SB PIN-13D PIN-13DP PIN-005E-550F UV-001 UV-005 UV-005D UV-005E UV-013D UV-013E UV-015 OSD-5-0 OSD15-0 OSD5-5T OSD15-5T OSD5.8-7Q OSD5.8-7U</p> <p>Pin Circle Dia.=0.200</p> <table border="1"> <thead> <tr> <th>P/N</th> <th>A</th> <th>B</th> </tr> </thead> <tbody> <tr> <td>OSD-Prefix Devices</td> <td>0.050</td> <td>0.130</td> </tr> <tr> <td>All Others</td> <td>0.102</td> <td>0.180</td> </tr> </tbody> </table> <p>Quartz Window: OSD5.8-7Q UV Transmissive Window: OSD5.8-7U</p>	P/N	A	B	OSD-Prefix Devices	0.050	0.130	All Others	0.102	0.180	<p>Products:</p> <p>PIN-6D PIN-6DP PIN-44D PIN-44DP UV-020 UV-035D UV-035E UV-035</p> <p>Pin Circle Dia.=0.295</p>																
P/N	A	B																																		
BPX-65R	0.070	0.200																																		
All Others	0.090	0.150																																		
P/N	A	B																																		
OSD-Prefix Devices	0.050	0.130																																		
All Others	0.102	0.180																																		
<p>Products:</p> <p>PIN-3CD PIN-3CDP BPX-65 OSD1-0 OSD1-5T OSD3-5T OSD1.2-7Q OSD1.2-7U</p> <p>Pin Circle Dia.=0.100</p> <table border="1"> <thead> <tr> <th>P/N</th> <th>A</th> <th>B</th> </tr> </thead> <tbody> <tr> <td>PIN-3CD / 3CDP</td> <td>0.087</td> <td>0.146</td> </tr> <tr> <td>BPX-65</td> <td>0.075</td> <td>0.200</td> </tr> <tr> <td>OSD-Prefix Devices</td> <td>0.080</td> <td>0.200</td> </tr> </tbody> </table> <p>Quartz Window: OSD1.2-7Q UV Transmissive Window: OSD1.2-7U</p>	P/N	A	B	PIN-3CD / 3CDP	0.087	0.146	BPX-65	0.075	0.200	OSD-Prefix Devices	0.080	0.200	<p>Products:</p> <p>PIN-125DPL</p> <p>Pin Circle Dia.=0.100</p>	<p>Products:</p> <p>PIN-HR005 PIN-HR008 PIN-HR020 PIN-HR026 PIN-HR040</p> <p>Pin Circle Dia.=0.100</p>																						
P/N	A	B																																		
PIN-3CD / 3CDP	0.087	0.146																																		
BPX-65	0.075	0.200																																		
OSD-Prefix Devices	0.080	0.200																																		

All units in inches. Pinouts are bottom view.

Low Profile

Products:
 PIN-10DI
 PIN-10DPI
 PIN-10DPI/SB
 UV-50L
 UV-100L

Pin Circle Dia.=0.73

BNC

Products:
 PIN-10D
 PIN-10DP
 PIN-10DP/SB
 UV-50
 UV-100

Outer Contact — Anode	PIN-10D, PIN-10DP, PIN-10DP/SB
Outer Contact — Cathode	UV-50, UV-100

BNC

Products:
 PIN-25D
 PIN-25DP

Outer Contact — Anode

Special BNC

Products:
 PIN-10AP
 PIN-10DF

P/N	A	B	C
PIN-10DF	0.217	0.330	1.020
PIN-10AP	0.386	0.550	1.415

Special Plastic

Products:
 FIL-5C
 FIL-20C
 FIL-UV20
 FIL-C4DG

P/N	A	B
FIL-5C FIL-20C	0.060	0.130
FIL-UV005 FIL-UV20 FIL-C4DG	0.087	0.152

P/N	1	2	3	4	5	6
FIL-5C FIL-20C FIL-UV005	a	-	c	a	-	c
FIL-UV20	c	-	a	c	-	a
FIL-C4DG	c	a	c	c	a	c

Special Plastic

Products:
 FIL-44C
 FIL-100C
 FIL-UV50
 FIL-UV100
 FIL-C10DG

P/N	A	B
FIL-44C FIL-100C	0.052	0.130
FIL-UV50 FIL-UV100 FIL-C10DG	0.090	0.155

P/N	1	2	3	4	5	6	7	8
FIL-44C FIL-100C	a	-	-	c	a	-	-	c
FIL-UV50 FIL-UV100	c	-	-	a	c	-	-	a
FIL-C10DG	c	a	a	c	c	a	a	c

All units in inches. Pinouts are bottom view.

22 TO-5

Products:

XUV-005

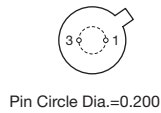
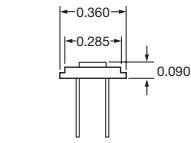

23 TO-8

Products:

XUV-020
XUV-035

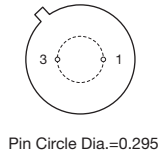
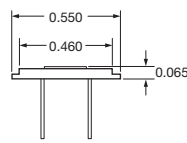

24 TO-8

Products:

PIN-DSIn-TEC

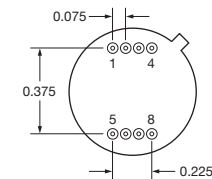
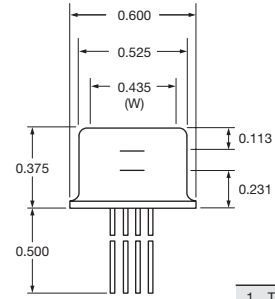

Pinout	
1	TEC (-)
2	Thermistor
3	Thermistor
4	TEC (+)
5	Bottom InGaAs, Cathode
6	Bottom InGaAs, Anode
7	Top Silicon, Anode
8	Top Silicon, Cathode

25 Special Ceramic / Plastic

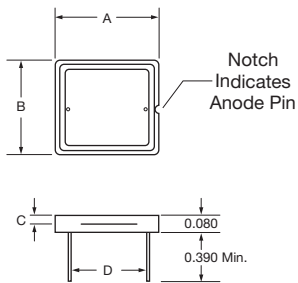

P/N	Dimensions			
	A	B	C	D
UV-005EC	0.400	0.350	0.030	0.280
UV-035EC	0.400	0.350	0.030	0.290
UV-100EC	0.650	0.590	0.048	0.500
UV-005DC	0.400	0.350	0.030	0.280
UV-035DC	0.400	0.350	0.030	0.290
UV-100DC	0.650	0.590	0.053	0.500
XUV-50C	0.650	0.590	0.027	0.490
XUV-100C	0.650	0.590	0.027	0.490
RD-100	0.650	0.590	0.027	0.490
RD-100A	0.650	0.590	0.027	0.490
UV-35P	0.390	0.345	0.050	0.275
OSD35-7CO	0.390	0.350	---	0.290
OSD35-LR-A	0.390	0.350	---	0.290
OSD35-LR-D	0.390	0.350	---	0.290

Note: OSD35-prefix packages come with 0.31" (min.) leads

26 TO-8

Products:

RD-100
RD-100A
UV-35P
UV-005EC
UV-035EC
UV-100EC
UV-005DC
UV-035DC
UV-100DC
XUV-50C
XUV-100C
OSD35-7CO
OSD35-LR-A
OSD35-LR-D

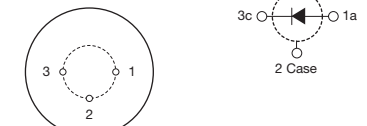
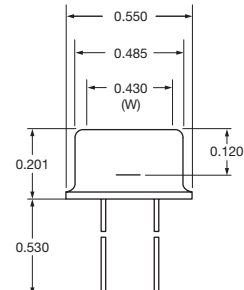

Pin Circle Dia.=0.295

27 Special Plastic

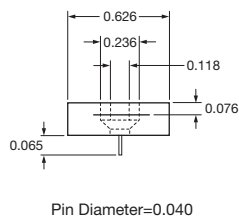
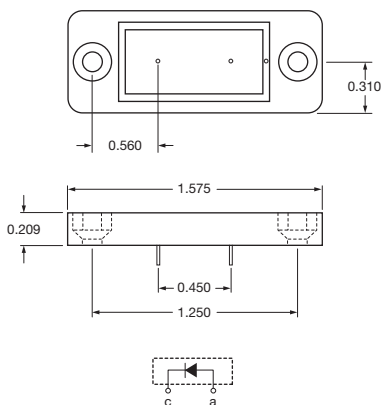

Products:

PIN-220D
PIN-220DP
PIN-220DP/SB

28 BNC

Products:

XUV-100

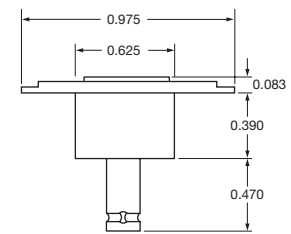

BNC Connector
Outer Contact = Cathode

Mechanical Specifications

All units in inches. Pinouts are bottom view.

68 TO-18	69 TO-18	70 TO-5
<p>Products: APD-300 APD-500</p> <p>Pin Circle Dia.=0.100</p>	<p>Products: APD-300L APD-500L</p> <p>Pin Circle Dia.=0.100</p>	<p>Products: APD-900 APD-1500 APD-3000</p> <p>Pin Circle Dia.=0.200</p>
71 Plastic	72 TO-8	73 TO-8
<p>Products: CD-1705</p> <p>ANODE CATHODE</p>	<p>Products: OSD-60-0</p> <p>CATHODE & CASE ANODE</p>	<p>Products: QD50-0</p> <p>CATHODE & CASE Q4 Q3 Q2 QUADRANT ANODE 1</p>
74 Special	75 TO-5	76 Plastic Molded
<p>Products: OSD100-0A OSD100-5TA</p> <p>RED DOT INDICATES CATHODE LEAD</p>	<p>Products: DLS-2S</p> <p>Pin Circle Dia.= 0.200 Bottom View</p>	<p>Products: OS-P200</p> <p>OPTICAL C</p>