

Silicon APD Typical Spectral Response ($T_A = 23^\circ\text{C}$, $M = 100$)

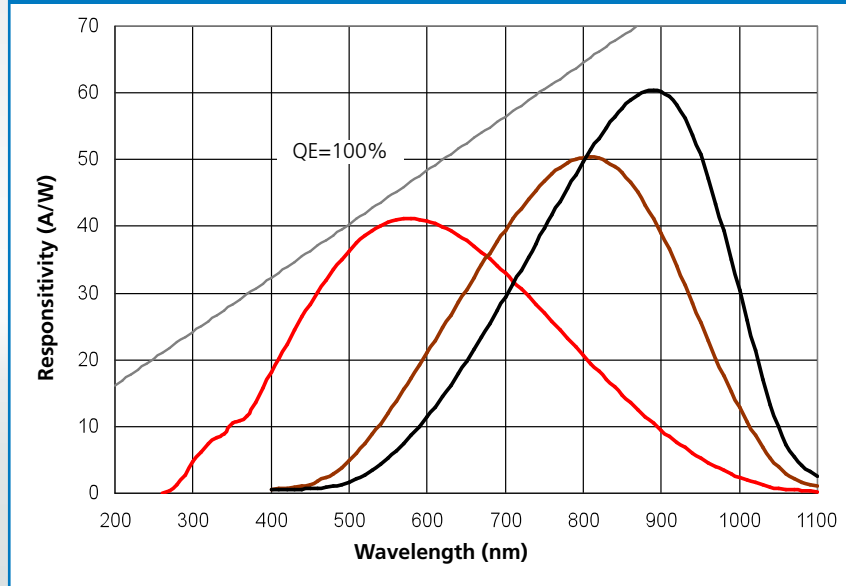

- Series 6
- Series 8
- Series 9

Silicon APD Model Number Description: **APDxx - y - zzz - pppp**

		Options	Descriptions
APD	Avalanche Photodiode		
xx	Active Area Size	02	Diameter 0.2 mm
		05	Diameter 0.5 mm
		10	Diameter 1.0 mm
		15	Diameter 1.5 mm
		30	Diameter 3.0 mm
		50	Diameter 5.0 mm
y	Optimal Spectral Band	6	630 nm
		8	800 nm
		9	900 nm
zzz	Breakdown Voltage	150	Low Voltage Operation
		250	High Voltage Operation
pppp	Package Style <i>(refer to mechanical specifications)</i>	T52, T46	TO-18 style
		T05, T5H, T5i	TO-5 style
		T08, T8H	TO-8 style

SELECTION GUIDE AND NOMENCLATURE

ELECTRO-OPTICAL CHARACTERISTICS ($T_A = 23^\circ\text{C}$, typical values at gain listed, unless otherwise specified)

Model	Active Area Dia.	Optimal Wavelength	Responsivity @ Gain M	Breakdown Voltage		Dark Current	Bandwidth	Capacitance	Package	Gain M
	(mm)	(nm)	Typ. (A/W)	Typ. (V)	Max (V)	Max (nA)	Typ. (MHz)	Typ. (pF)	(*)	

SERIES 6 - 150: Visible Spectrum Optimized

APD02-6-150	0.2	630	40	150	200	5	900	3	TO-18	100
APD05-6-150	0.5	630	40	150	200	5	400	8	TO-18	100
APD10-6-150	1	630	40	150	200	5	250	18	TO-18	100
APD15-6-150	1.5	630	40	150	200	15	100	35	TO-5	100
APD30-6-150	3	630	20	150	200	30	20	140	TO-5	50
APD50-6-150	5	630	20	150	200	100	8	365	TO-8	50

SERIES 8 - 150: High Bandwidth Applications

APD02-8-150	0.2	800	50	150	250	1	1000	1.5	TO-18	100
APD05-8-150	0.5	800	50	150	250	1	900	3	TO-18	100
APD10-8-150	1	800	50	150	250	2	600	6	TO-18	100
APD15-8-150	1.5	800	50	150	250	5	350	10	TO-5	100
APD30-8-150	3	800	30	150	250	10	65	40	TO-5	60
APD50-8-150	5	800	20	150	250	30	25	105	TO-8	40

SERIES 9 - 250: NIR Enhanced Series

APD02-9-250	0.2	900	60	250	350	2	250	0.9	TO-18	100
APD05-9-250	0.5	900	60	250	350	3	220	1.5	TO-18	100
APD10-9-250	1	900	60	250	350	5	210	2.4	TO-18	100
APD15-9-250	1.5	900	60	250	350	10	200	4.4	TO-5	100

SERIES 15 - 60: InGaAs APD

APD007-15-60	0.075	1550	9	60	100	20 **	2000	1.2	TO-18	10
APD020-15-60	0.2	1550	9	60	100	50 **	1000	2.5	TO-18	10

(*) Please refer to Mechanical Specification for package options available

(**) Condition: $V_r = 0.9 \times V_{br}$

For further assistance on Avalanche Photodiode selection or customization, please contact one of our Application Engineers at +1-310-978-0516.

No responsibility is assumed for inaccuracies or omission. OSI Optoelectronics Inc. reserves the right to change products and specifications.

APD Series 6-150

Silicon Avalanche Photodiodes, 600nm band

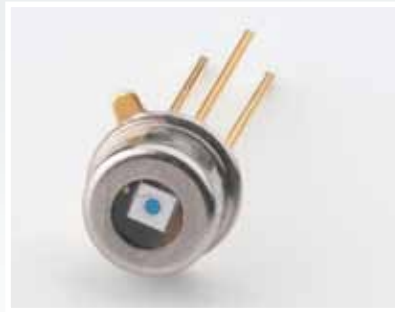
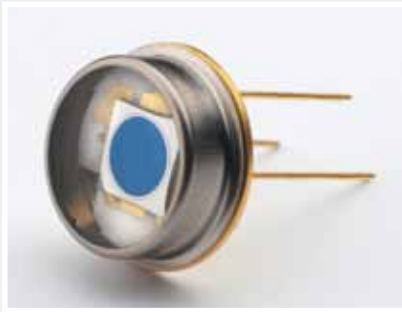

FEATURES

- High Sensitivity at Visible Spectrum
- Low Noise
- Low Bias Operation
- Low Temperature Coefficient: 0.14 V/°C

APPLICATIONS

- Analytical instrument
- Low-light-level measurement

GENERAL RATINGS / ABSOLUTE MAXIMUM RATINGS

Product Model	Active Area		Package Style*2	Storage Temperature (°C)		Operating Temperature (°C)	
	Diameter*1 (mm)	Area (mm ²)		Min	Max	Min	Max
APD02-6-150-xxxx	0.2	0.03	T52, T52L	-55	+125	-40	+100
APD05-6-150-xxxx	0.5	0.19		-55	+125	-40	+100
APD10-6-150-xxxx	1.0	0.78		-55	+125	-40	+100
APD15-6-150-xxxx	1.5	1.77	TO5, T5H, T5i	-55	+125	-40	+100
APD30-6-150-xxxx	3.0	7.0		-55	+125	-40	+100
APD50-6-150-xxxx	5.0	19.6	TO8, T8H	-55	+125	-40	+100

ELECTRO-OPTICAL CHARACTERISTICS (T_A = 23°C, typical values at gain listed, unless otherwise specified)

Product Model	Responsivity @ Gain M λ = 630 nm (A/W)	Dark Current Gain M (nA)		Ct Gain M (pF)	Q.E. M = 1 λ = 630 nm (%)	Breakdown Voltage 100uA (V)		Temperature Coefficient of Breakdown Voltage (V/°C)	Bandwidth -3dB Gain M λ = 630 nm (MHz)	Excess Noise Figure Gain M λ = 630 nm	Gain M λ = 630 nm
		Typ	Max			Typ	Max				
		APD02-6-150-xxxx	40			0.2	5				
APD05-6-150-xxxx	0.2	5		8	80	150	200	0.14	400	0.3	100
APD10-6-150-xxxx	0.3	5		18	80	150	200	0.14	250	0.3	100
APD15-6-150-xxxx	0.5	15		35	80	150	200	0.14	100	0.3	100
APD30-6-150-xxxx	20	1	30	140	80	150	200	0.14	20	0.3	50
APD50-6-150-xxxx	20	3	100	365	80	150	200	0.14	8	0.3	50

*1: Area in which a typical gain can be obtained

*2: Please refer to mechanical outline section to choose desired TO can package options. Cap with micro-lens is available for small active area size.

APD SERIES 6-150

Silicon Avalanche Photodiodes, 600 nm band

Typ. Spectral Response ($T_A = 23^\circ\text{C}$, $M = 100$)

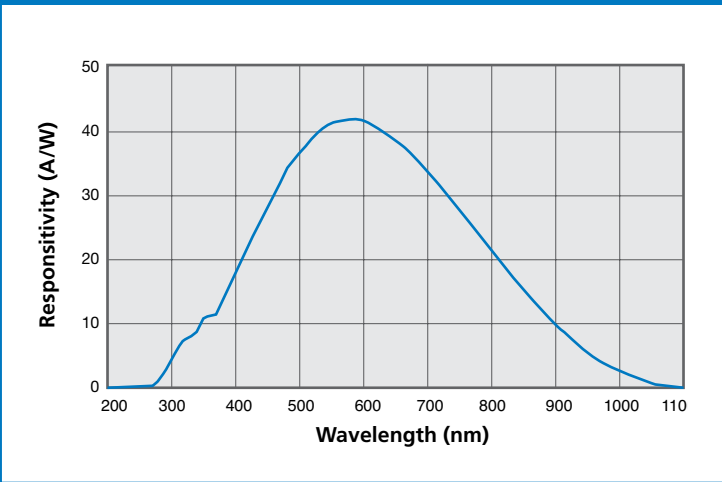

Typ. Quantum Efficiency vs. Wavelength ($T_A = 23^\circ\text{C}$)

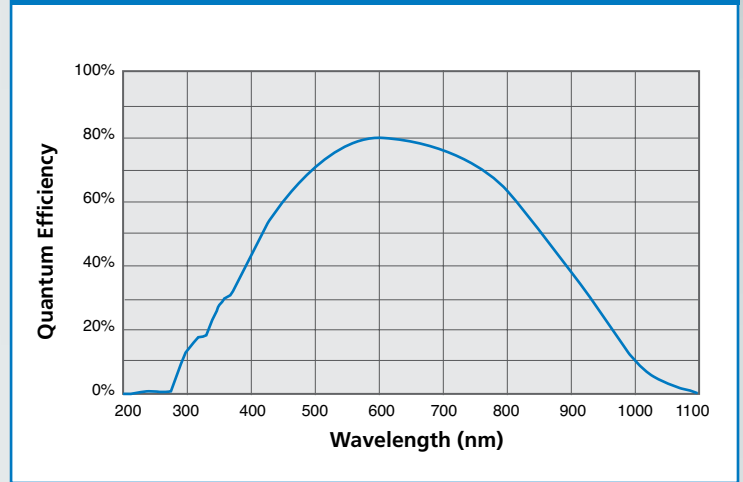

Typ. Dark Current vs. Reverse Bias ($T_A = 23^\circ\text{C}$)

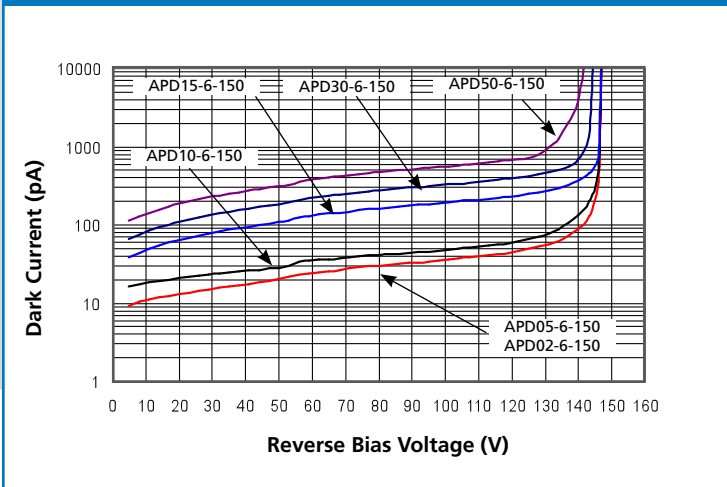

Typ. Gain vs. Reverse Bias ($T_A = 23^\circ\text{C}$, 630 nm)

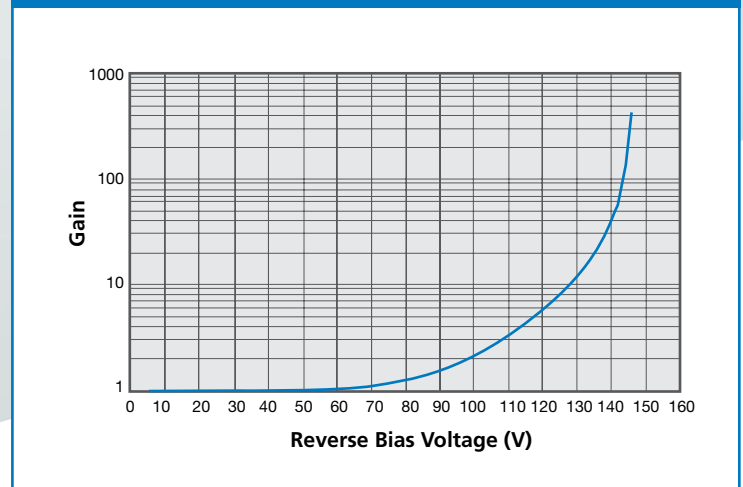

Typ. Capacitance vs. Reverse Bias ($T_A = 23^\circ\text{C}$, $f = 1\text{MHz}$)

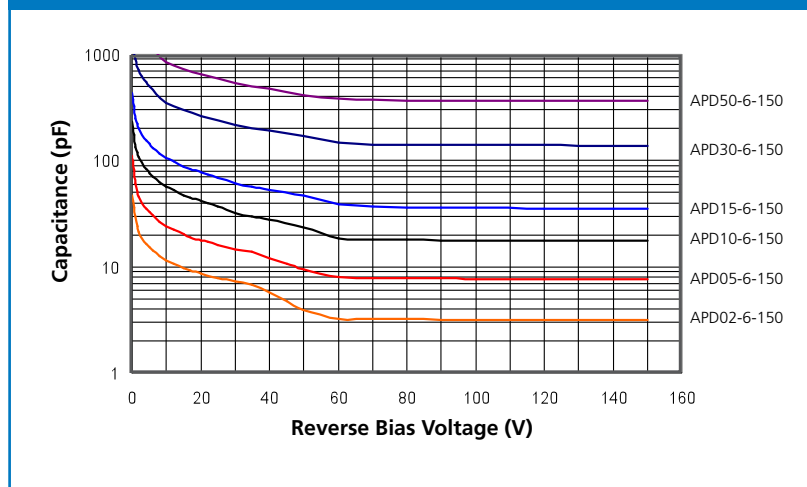

Mechanical Specifications

All units in mm. Pinouts are bottom view.

T52

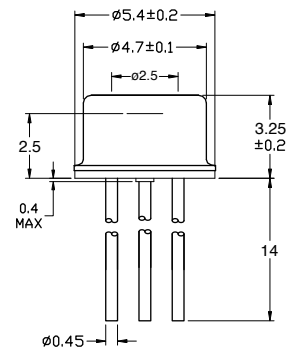

	Products
Series 6-150	APD02-6-150-T52
	APD05-6-150-T52
	APD10-6-150-T52
Series 8-150	APD02-8-150-T52
	APD05-8-150-T52
	APD10-8-150-T52
Series 9-250	APD02-9-250-T52
	APD05-9-250-T52
	APD10-9-250-T52

Glass window may extend a maximum of 0.1 mm above the upper surface of the cap.

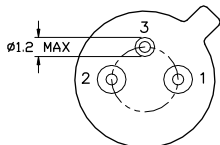

Pin Circle Dia = 2.54

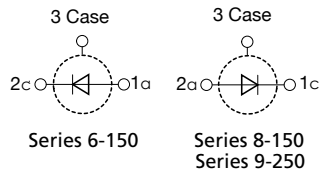

T52L (with lens)

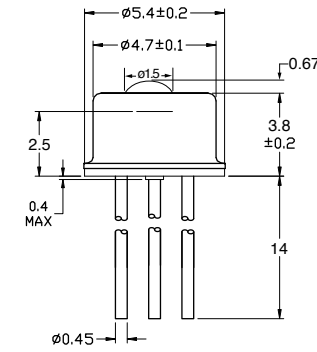

	Products
Series 6-150	APD02-6-150-T52L
	APD05-6-150-T52L
Series 8-150	APD02-8-150-T52L
	APD05-8-150-T52L
Series 9-250	APD02-9-250-T52L
	APD05-9-250-T52L

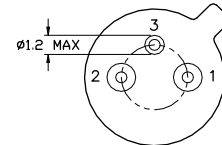

Pin Circle Dia = 2.54

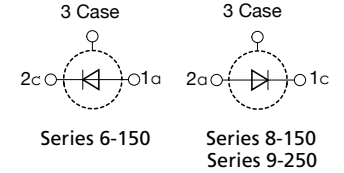

T46

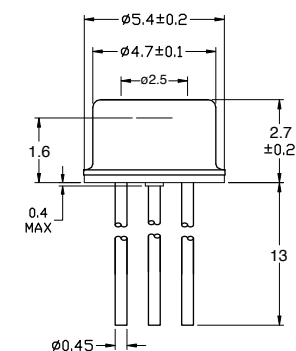

	Products
Series 15-60	APD007-15-60-T46
	APD020-15-60-T46

Window is broadband A/R coated
Centered at 1300nm.

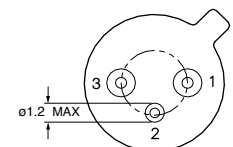

Pin Circle Dia = 2.54

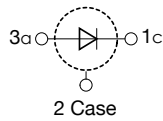

T46L (with lens)

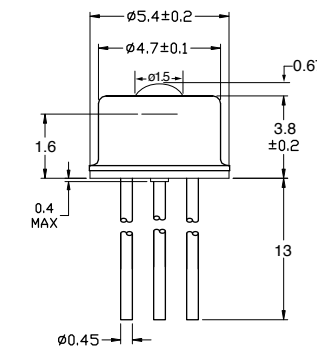

	Products
Series 15-60	APD007-15-60-T46L
	APD020-15-60-T46L

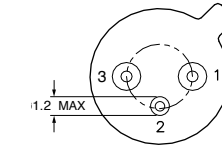

Pin Circle Dia = 2.54

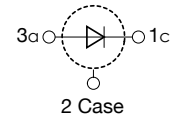

T05

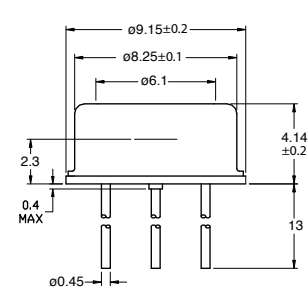

	Products
Series 6-150	APD15-6-150-T05
	APD30-6-150-T05
Series 8-150	APD15-8-150-T05
	APD30-8-150-T05
Series 9-250	APD15-9-250-T05

Glass window may extend a maximum of 0.2 mm above the upper surface of the cap.

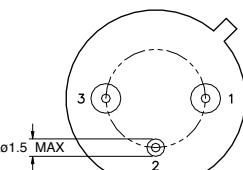

Pin Circle Dia = 5.08

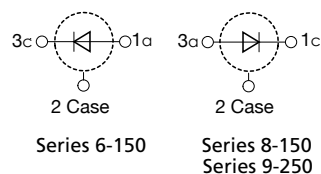

T5H

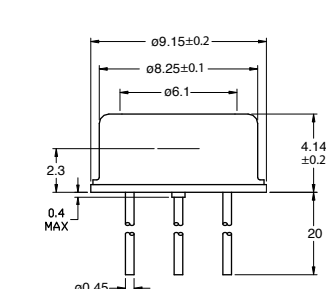

	Products
Series 6-150	APD15-6-150-T5H
	APD30-6-150-T5H
Series 8-150	APD15-8-150-T5H
	APD30-8-150-T5H
Series 9-250	APD15-9-250-T5H

Glass window may extend a maximum of 0.2 mm above the upper surface of the cap.

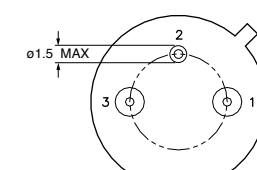

Pin Circle Dia = 5.08

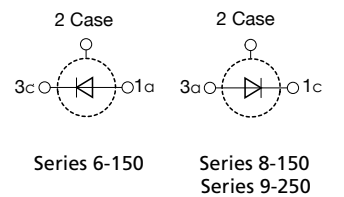

Mechanical Specifications

All units in mm. Pinouts are bottom view.

T5i

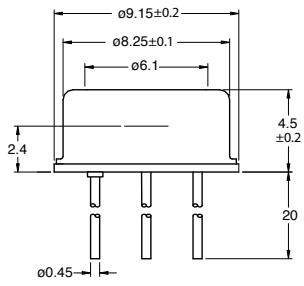

	Products
Series 6-150	APD15-6-150-T5i
	APD30-6-150-T5i
Series 8-150	APD15-8-150-T5i
	APD30-8-150-T5i
Series 9-250	APD15-9-250-T5i

Glass window may extend a maximum of 0.2 mm above the upper surface of the cap.

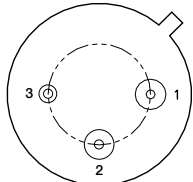

Pin Circle Dia = 5.08

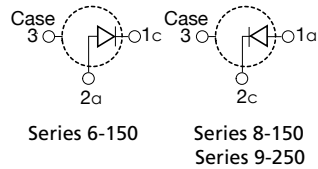

T08

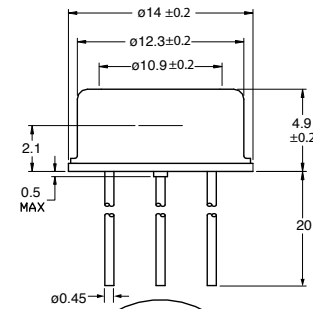

	Products
Series 6-150	APD50-6-150-T08
Series 8-150	APD50-8-150-T08

Glass window may extend a maximum of 0.2 mm above the upper surface of the cap.

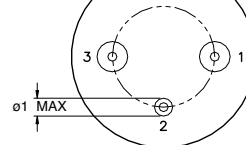

Pin Circle Dia = 7.5

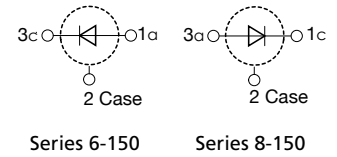

T8H

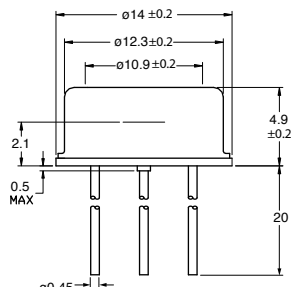

	Products
Series 6-150	APD50-6-150-T8H
Series 8-150	APD50-8-150-T8H

Glass window may extend a maximum of 0.2 mm above the upper surface of the cap.

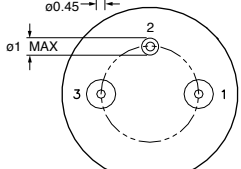

Pin Circle Dia = 7.5

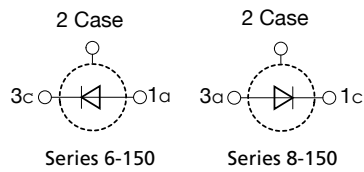

WCER

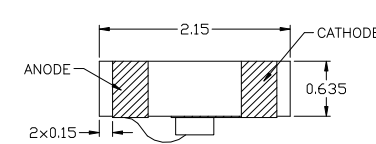

	Products
Series 15-60	APD007-15-60-WCER
	APD020-15-60-WCER

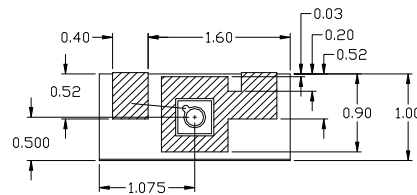

Die is mounted with a tolerance of $\pm 75\mu\text{m}$.

