

## BF1 FUSE RATED 58V



### Description

This BF1 fuse is rated at 58V and offers a bolt-on fuse for high current wiring protection. Current rating 30A - 200A; with transparent housing material for easy detection of blown fuses.

### Specifications

Housing Material:	Heat Resistant 94-V0 Thermoplastic Visible melting element
Terminals:	Copper alloy, gal. Sn 2 x M5 or M6 bolts, distance 30 mm
Mounting Torque M5:	4.5 Nm +/- 1Nm
Mounting Torque M6:	6.0 Nm +/- 1Nm
Interrupting Rating:	1000A @ 58 VDC
Complies with:	ISO 8820-5 UL 248 Special Purpose Fuses
Operating temperature:	-40 to 125 degrees C











### Ordering Information

Part Number	Package Size
142.5631.xxx2	500

### Time-Current Characteristics

% of Rating	Opening Time Min / Max (s)	
	30-150A Fuses	200A Short Circuit Protectors
75	- / -	360,000 s / -
100	360,000 s / -	- / -
110	14,400 s / -	- / -
150	90 s / 3,600 s	- / -
200	3 s / 100 s	1 s / 15 s
300	0.300 s / 3 s	- / -
350	- / -	0.300 s / 5 s
500	0.100 s / 1 s	- / -
600	- / -	0.100 s / 1 s

### Ratings

Part Number M5	Part Number M6	Current Rating	Housing Material Color	Typ. Voltage Drop	Cold Resistance	I <sup>2</sup> t
142.5631.5302 <sup>1</sup>	142.7010.5302 <sup>1</sup>	30 A		105 mV	2.70 mΩ	5,100 A <sup>2</sup> s
142.5631.5402	142.7010.5402	40 A		90 mV	1.56 mΩ	6,800 A <sup>2</sup> s
142.5631.5502	142.7010.5502	50 A		80 mV	1.03 mΩ	6,900 A <sup>2</sup> s
142.5631.5602	142.7010.5602	60 A		75 mV	0.75 mΩ	16,200 A <sup>2</sup> s
142.5631.5702	142.7010.5702	70 A		70 mV	0.64 mΩ	22,000 A <sup>2</sup> s
142.5631.5802	142.7010.5802	80 A		70 mV	0.55 mΩ	25,600 A <sup>2</sup> s
142.5631.6102	142.7010.6102	100 A		70 mV	0.44 mΩ	42,500 A <sup>2</sup> s
142.5631.6122	142.7010.6122	125 A		70 mV	0.34 mΩ	62,500 A <sup>2</sup> s
142.5631.6152	142.7010.6152	150 A		70 mV	0.29 mΩ	83,400 A <sup>2</sup> s
142.5631.6202 <sup>2</sup>	142.7010.6202 <sup>2</sup>	200 A		70 mV	0.24 mΩ	126,000 A <sup>2</sup> s

Corresponding holder see Section "Fuse Holders."  
Note 1: Not UL rated Note 2: Short Circuit Protector only

## BF1 FUSE RATED 58V



### Dimensions

Dimensions in mm

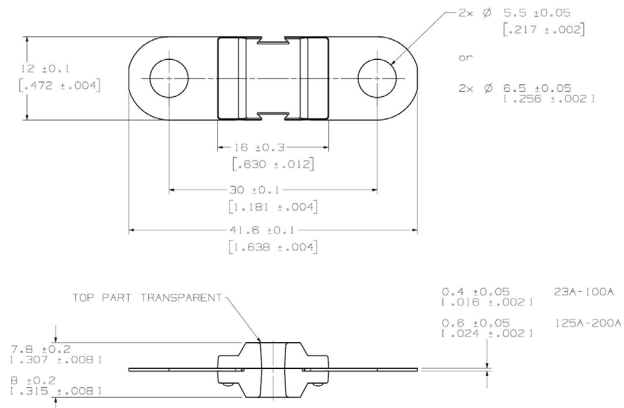

### Pre-Arcing Time-Limits

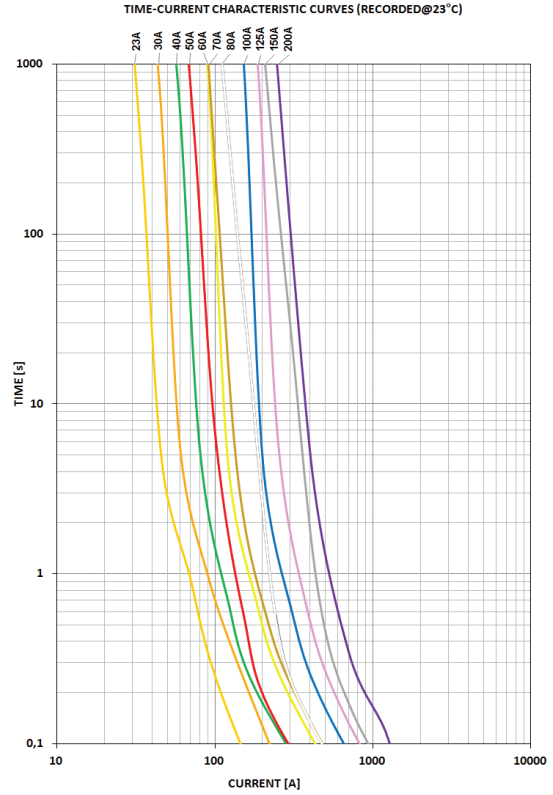

30 A - 150 A: FI = 1.25 (max. operating current:  $0.8 \times I_{rat}$  at 23°C)  
 200 A: FI = 2.00 (max. operating current:  $0.5 \times I_{rat}$  at 23°C)

### Derating

Individual derating curves by rating can be ordered through your Littelfuse contact person.