

Cable
assembliesD-Sub / Hoods
CentronicsMultiflex -
DIN41651

Modular

USB
IEEE1394

Switches

Powercords
PowerleadsDIN41612
Hardmetric

MiniDIN

Sockets / Strips
Jumper

Terminal Blocks

Memory Card

FFC / FPC

DIN 41612 (DIN EN 60603-2) Steckverbinder für gedruckte Schaltungen der ASSMANN WSW components wurden seinerzeit für die Verwendung in 19'' Zoll-Systemen im Kontaktraster 2,54mm entwickelt. Dieses Steckverbindersystem erfreut sich nach wie vor großer Beliebtheit und wird aufgrund seiner Variantenvielfalt auch in Applikationen mit hohen Polzahlen vorgesehen. DIN 41612 Steckverbinder stellen ein besonders zuverlässiges und erprobtes Verbindungssystem dar, welches über alle gängigen Anschlusstechniken z.B.: Einlöt-, Wire Wrap und Press-Fit verfügt.

Typische Anwendungen für diese Steckverbinderfamilie finden sich in den Anwenderbereichen der Industrie, Telekommunikation, Medizintechnik, Militärtechnik, Bahntechnik, Mess- und Regeltechnik, Automatisierungs- und Steuerungstechnik, Luft- und Raumfahrttechnik, Computertechnik und vielen weiteren Bereichen.

ASSMANN WSW components deckt nahezu das gesamte Spektrum an Bauformen ab wie B, B1/2, C, C1/2, R, R1/2, Q, Q1/2 und M ab. Neben den Standardprodukten liefert die ASSMANN WSW components auch eine Vielzahl an kundenspezifischen Lösungen und Sonderbestückungen. Hochtemperaturisolerkörpervarianten und Clipversionen zum Fixieren der Steckverbinder auf der Leiterplatten vervollständigen die Produktpalette. Die Einpresstechnik wird über das wohlbekannte 'Nadelöhr' Kontaktdesign realisiert.

Aus dem Hause ASSMANN WSW components sind weiterhin die traditionellen Steckverbinder nach DIN 41617 im Raster 2,50mm erhältlich, die einst die Vorgänger der o.g. DIN 41612 Steckverbinderfamilie waren. Dieses Steckverbindersystem zeichnet sich durch seine erprobte „Robustheit“ aus. Steckverbinder nach DIN 41617 können in drei Polzahlen, 13-, 21-, und 31-polig, sowohl als Stift- als auch als Federleisten geliefert werden. Hauptsächlich kommt hier die versilberte Ausführung zum Einsatz.

DIN 41612 (Din EN 60603-2) connectors for printed circuits of ASSMANN WSW components have been developed as connector component for 19'' inch systems with a contact pitch of 2,54mm. Today, this connector family is well-known and still used on high volume applications due to the full range of products and the wide range of available pin counts. Key characteristics of this DIN 41612 product range are high reliability and the availability many different contact technologies eg. : THT, Wire-Wrap and Press-fit.

Typical applications for this connector system are to be found in the field of industry, telecom, medicine, military, trains, measurement and instrumentation, automation, control devices, aerospace and computers and many other areas.

ASSMANN WSW components offers the complete range of DIN 41612 connectors like style B, B1/2, C, C 1/2, R, R1/2, Q, Q1/2 and style M. Beside standard products ASSMANN WSW components GmbH deliver a variety of custom specific solutions, customer specific contact loadings, high temperature insulators and board locks. The design of the press-fit contacts is based on the well-known 'eye of the needle' - design.

DIN 41617 connectors traditionally offered by ASSMANN WSW components based on the 2,50mm contact pitch. Known as the forerunner of the DIN 41612, this connector system still shows a solid robustness and is used in today applications. These connectors can be delivered in three different pin counts as there are 13-, 21-, and 31 contacts, as male and/or female connector. The commonly used plating is based on silver surface.

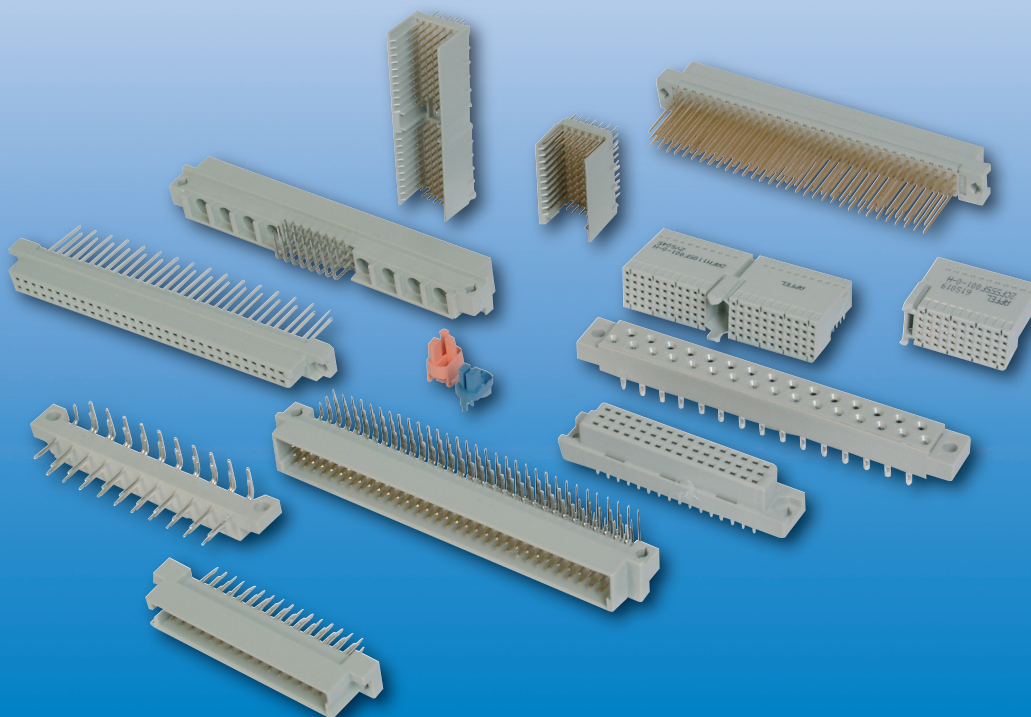

Produktbeschreibung

Seite

DIN41612, Bauform B, Messerleiste, Raster 2.54mm	198
DIN41612, Bauform B, Federleiste, gerade, Raster 2.54mm	199
DIN41612, Bauform C, Messerleiste, Raster 2.54mm	200
DIN41612, Bauform C, Federleiste, gerade, Raster 2.54mm	201
DIN41612, Bauform Q, Messerleiste, gerade, Raster 2.54mm	202
DIN41612, Bauform Q, Federleiste, abgewinkelt, Raster 2.54mm	203
DIN41612, Bauform R, Messerleiste, gerade, Raster 2.54mm	204
DIN41612, Bauform R, Federleiste, abgewinkelt, Raster 2.54mm	205
DIN41617, Messerleiste, abgewinkelte Lötstifte, Raster 2.50mm	206
DIN41617, Federleiste, Raster 2.50mm	207
2.00mm Hard Metric, Bauform A, Messerleiste, gerade	209
2.00mm Hard Metric, Bauform B25, Messerleiste, gerade	212
2.00mm Hard Metric, Bauform B22, Messerleiste, gerade	214
2.00mm Hard Metric, Bauform B19, Messerleiste, gerade	216
2.00mm Hard Metric, Bauform C, Messerleiste, gerade	218
2.00mm Hard Metric, Bauform A, Federleiste, abgewinkelt	220
2.00mm Hard Metric, Bauform B25, Federleiste, abgewinkelt	221
2.00mm Hard Metric, Bauform B22, Federleiste, abgewinkelt	222
2.00mm Hard Metric, Bauform B19, Federleiste, abgewinkelt	223
2.00mm Hard Metric, Bauform C, Federleiste, abgewinkelt	224

Product description

page

DIN41612, style B, male, pitch 2.54mm	198
DIN41612, style B, female, straight, pitch 2.54mm	199
DIN41612, style C, male, pitch 2.54mm	200
DIN41612, style C, female, straight, pitch 2.54mm	201
DIN41612, style Q, male, straight, pitch 2.54mm	202
DIN41612, style Q, female, right-angled, pitch 2.54mm	203
DIN41612, style R, male, straight, pitch 2.54mm	204
DIN41612, style R, female, right angled, pitch 2.54mm	205
DIN41617, male, right-angled solder pins, pitch 2.50mm	206
DIN41617, female, pitch 2.50mm	207
2.00mm Hard Metric, style A, male, straight	209
2.00mm Hard Metric, style B25, male, straight	212
2.00mm Hard Metric, style B22, male, straight	214
2.00mm Hard Metric, style B19, male, straight	216
2.00mm Hard Metric, style C, male, straight	218
2.00mm Hard Metric, style A, female, right-angled	220
2.00mm Hard Metric, style B25, female, right-angled	221
2.00mm Hard Metric, style B22, female, right-angled	222
2.00mm Hard Metric, style B19, female, right-angled	223
2.00mm Hard Metric, style C, female, right-angled	224



- Cable assemblies
- D-Sub / Hoods Centronics
- Multiflex - DIN41651
- Modular
- USB IEEE1394
- Switches
- Powercards Powerinlets
- DIN41612 Hardmetric
- MiniDIN
- Sockets / Strips Jumper
- Terminal Blocks
- Memory Card
- FFC / FPC

- Cable assemblies
- D-Sub / Hoods Centronics
- Multiflex - DIN41651
- Modular
- USB IEEE1394
- Switches
- Powercords Powerlets
- DIN41612 Hardmetric
- MiniDIN
- Sockets / Strips Jumper
- Terminal Blocks
- Memory Card
- FPC / FPC

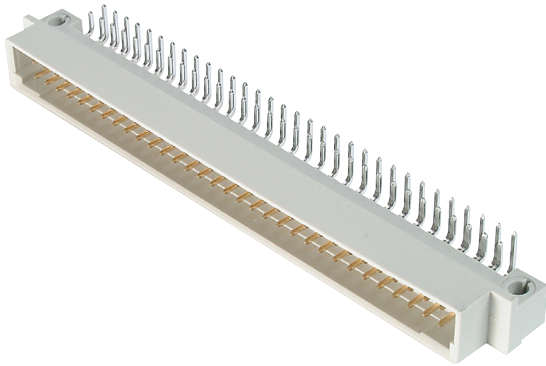

Isolierkörpermaterial
PBT, UL94V-0

Kontaktmaterial
Messing

Kontaktoberfläche
Ni, Au / Sn

Kontaktwiderstand
40mΩ max

Isolationswiderstand
10¹²Ω Min

Strombelastbarkeit
2A

Betriebstemperatur
-55°C - +125 °C

Betriebsspannung
250V AC

Prüfspannung
1000V AC

Verpackung
Blisterverpackung

Insulator material
PBT, UL94V-0

Contact material
Brass

Plating
Ni, Au / Sn

Contact resistance
40mΩ max

Insulation resistance
10¹²Ω min

Current rating
2A

Operating temperature
-55°C to +125°C

Operating voltage
250V AC

Test voltage
1000V AC

Packing
Tray packing

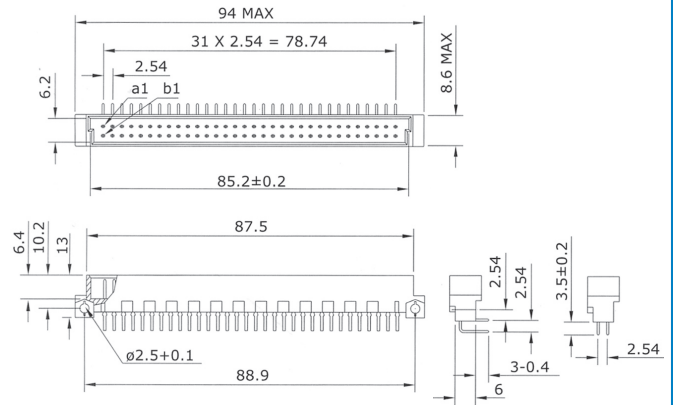
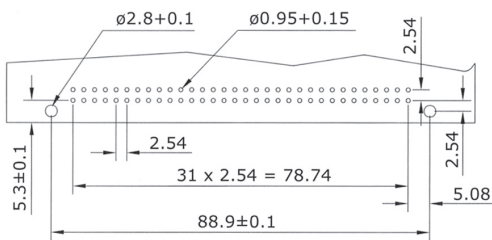

Bestellcode / Ordercode

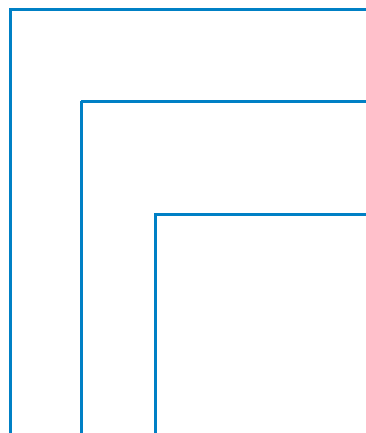

Bestückung

64ab* / 32a / 32ab* / 16a

Ausführung, Pinlänge

- R - abgewinkelt, 3mm (0.6x0.6)
- T - gerade, 3.5mm (0.6x0.6)

Gütestufe

- - Stufe 3 *
- 2 - Stufe 2
- 1 - Stufe 1

Positions loaded

64ab* / 32a / 32ab* / 16a

Version, tail length

- R - right-angled, 3mm (0.6x0.6)
- T - straight, 3.5mm (0.6x0.6)

Quality class

- - Class 3 *
- 2 - Class 2
- 1 - Class 1

A - B M x x - x

Bitte „x“ durch die geeignete Option ersetzen
 Please replace „x“ with appropriate option

* Standard

Isolierkörpermaterial

PBT, UL94V-0

Kontaktmaterial

Phosphorbronze

Kontaktfläche

Ni, Au / Sn

Kontaktwiderstand

20mΩ max

Isolationswiderstand

10¹²Ω Min

Strombelastbarkeit

2A

Betriebstemperatur

-40°C - +105°C

Betriebsspannung

125V AC

Prüfspannung

1000V AC

Verpackung

Blisterverpackung

Insulator material

PBT, UL94V-0

Contact material

Phosphor bronze

Plating

Ni, Au / Sn

Contact resistance

20mΩ max

Insulation resistance

10¹²Ω min

Current rating

2A

Operating temperature

-40°C to +105°C

Operating voltage

1250V AC

Test voltage

1000V AC

Packing

Tray packing

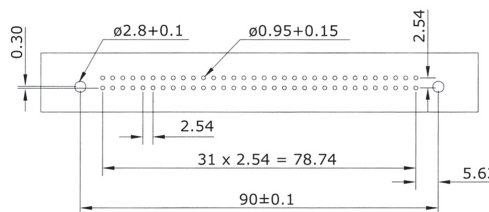
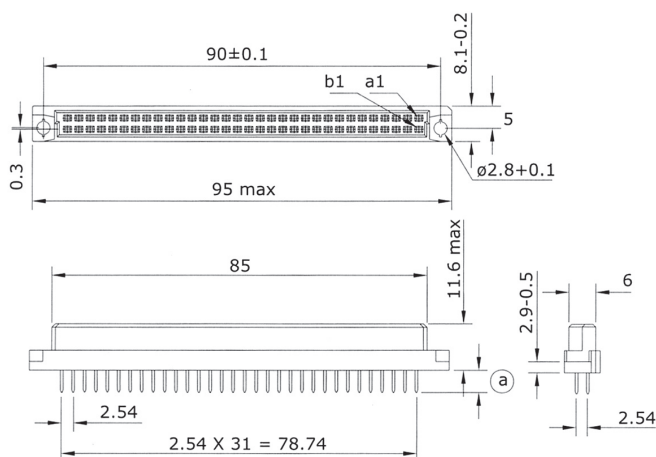
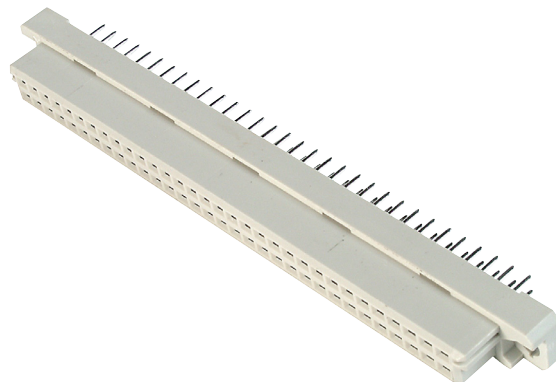

Bestellcode / Ordercode

Bestückung

64ab* / 32a / 32ab* / 16a

Positions loaded

64ab* / 32a / 32ab* / 16a

Pinlänge a

- T - 4.0mm* (0.30 x 0.38)
- T2.5 - 2.5mm* (0.30 x 0.38)
- WAB - 13.0mm* (0.60 x 0.60)
- WBB - 17.0mm (0.60 x 0.60)
- W5 - 5.0mm (0.60 x 0.60)
- W7 - 7.4mm (0.60 x 0.60)

Tail length a

- T - 4.0mm* (0.30 x 0.38)
- T2.5 - 2.5mm* (0.30 x 0.38)
- WAB - 13.0mm* (0.60 x 0.60)
- WBB - 17.0mm (0.60 x 0.60)
- W5 - 5.0mm (0.60 x 0.60)
- W7 - 7.4mm (0.60 x 0.60)

Gütestufe

- - Stufe 3 *
- 2 - Stufe 2
- 1 - Stufe 1

Quality class

- - Class 3 *
- 2 - Class 2
- 1 - Class 1

A - B F x x - x

Bitte „x“ durch die geeignete Option ersetzen
 Please replace „x“ with appropriate option

* Standard

- Cable assemblies
- D-Sub / Hoods Centronics
- Multiflex - DIN41651
- Modular
- USB IEEE1394
- Switches
- Powercards Powernets
- DIN41612 Hardmetric
- MiniDIN
- Sockets / Strips Jumper
- Terminal Blocks
- Memory Card
- FFC / FPC

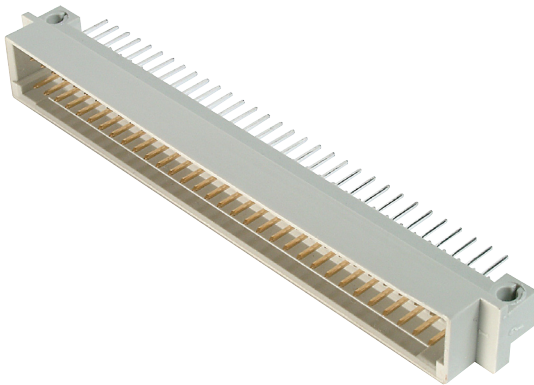

Isolierkörpermaterial
PBT, UL94V-0

Kontaktmaterial
Messing

Kontaktoberfläche
Ni, Au / Sn

Kontaktwiderstand
40mΩ max

Isolationswiderstand
10¹²Ω Min

Strombelastbarkeit
2A

Betriebstemperatur
-55°C - +125°C

Betriebsspannung
250V AC

Prüfspannung
1000V AC

Verpackung
Blisterverpackung

Insulator material
PBT, UL94V-0

Contact material
Brass

Plating
Ni, Au / Sn

Contact resistance
40mΩ max

Insulation resistance
10¹²Ω min

Current rating
2A

Operating temperature
-55°C to +125°C

Operating voltage
250V AC

Test voltage
1000V AC

Packing
Tray packing

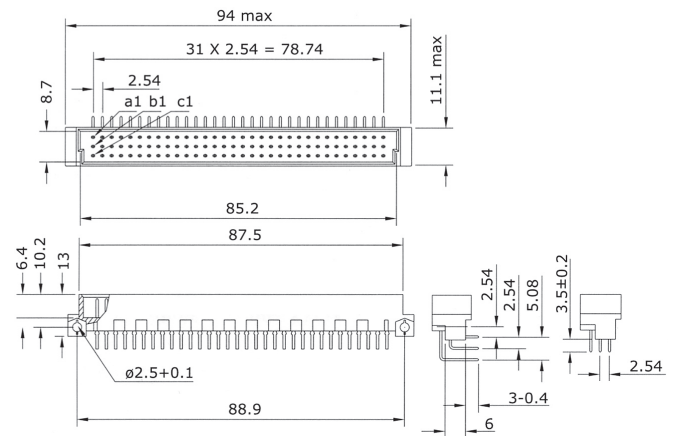
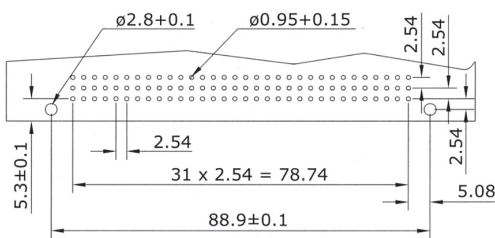

Bestellcode / Ordercode

Bestückung

96abc* / 64ac* / 64ab / 32a / 48abc / 32ac*

Positions loaded

96abc* / 64ac* / 64ab / 32a / 48abc / 32ac*

Ausführung, Pinlänge

R - abgewinkelt, 3mm(0.6x0.6)
 T - gerade, 3.5mm(0.6x0.6)

Version, tail length

R - right-angled, 3mm(0.6x0.6)
 T - straight, 3.5mm(0.6x0.6)

Gütestufe

- - Stufe 3*
 2 - Stufe 2
 1 - Stufe 1

Quality class

- - Class 3*
 2 - Class 2
 1 - Class 1

A - C M x x - x

Bitte „x“ durch die geeignete Option ersetzen
 Please replace „x“ with appropriate option

* Standard

Isolierkörpermaterial

PBT, UL94V-0

Kontaktmaterial

Messing

Kontaktfläche

Ni, Au / Sn

Kontaktwiderstand

40mΩ max

Isolationswiderstand

10¹²Ω Min

Strombelastbarkeit

2A

Betriebstemperatur

-55°C - +125°C

Betriebsspannung

250V AC

Prüfspannung

1000V AC

Verpackung

Blisterverpackung

Insulator material

PBT, UL94V-0

Contact material

Brass

Plating

Ni, Au / Sn

Contact resistance

40mΩ max

Insulation resistance

10¹²Ω min

Current rating

2A

Operating temperature

-55°C to +125°C

Operating voltage

250V AC

Test voltage

1000V AC

Packing

Tray packing

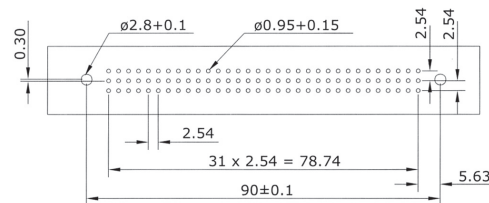
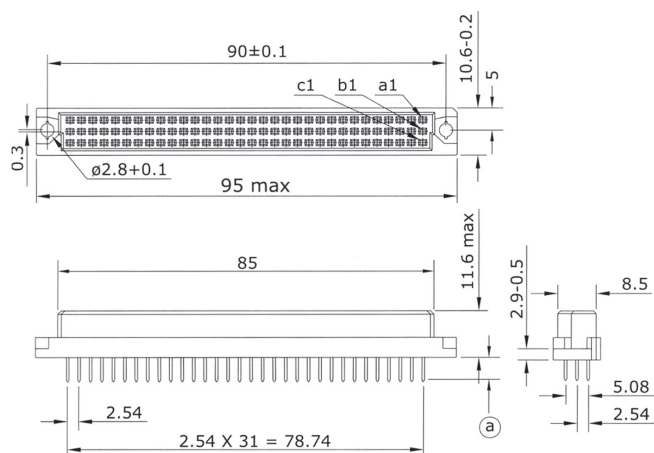
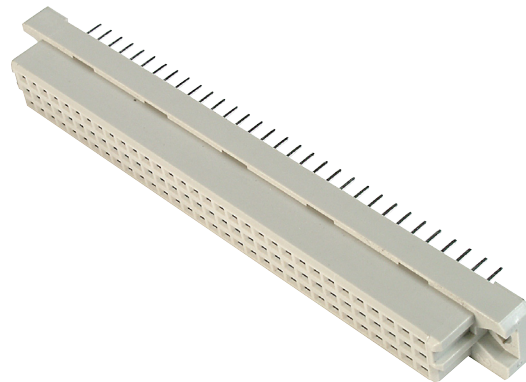

Bestellcode / Ordercode

Bestückung

96abc* / 64ac* / 64ab / 32a / 48abc / 32ac*

Positions loaded

96abc* / 64ac* / 64ab / 32a / 48abc / 32ac*

Pinlänge a

T - 4.0mm* (0.30 x 0.38)
 T2.5 - 2.5mm* (0.30 x 0.38)
 WAB - 13.0mm* (0.60 x 0.60)
 WBB - 17.0mm (0.60 x 0.60)
 W5 - 5.0mm (0.60 x 0.60)
 W7 - 7.4mm (0.60 x 0.60)

Tail length a

T - 4.0mm* (0.30 x 0.38)
 T2.5 - 2.5mm* (0.30 x 0.38)
 WAB - 13.0mm* (0.60 x 0.60)
 WBB - 17.0mm (0.60 x 0.60)
 W5 - 5.0mm (0.60 x 0.60)
 W7 - 7.4mm (0.60 x 0.60)

Gütestufe

- - Stufe 3*
 2 - Stufe 2
 1 - Stufe 1

Quality class

- - Class 3*
 2 - Class 2
 1 - Class 1

A - C F x x - x

Bitte „x“ durch die geeignete Option ersetzen
 Please replace „x“ with appropriate option

* Standard

- Cable assemblies
- D-Sub / Hoods Centronics
- Multiflex - DIN41651
- Modular
- USB IEEE1394
- Switches
- Powercords Powernets
- DIN41612 Hardmetric
- MiniDIN
- Sockets / Strips Jumper
- Terminal Blocks
- Memory Card
- FFC / FPC

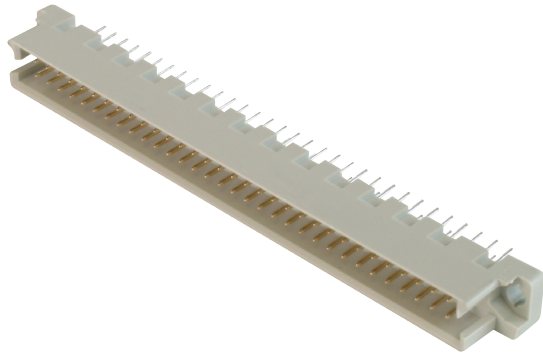

Isolierkörpermaterial

PBT, UL94V-0

Kontaktmaterial

Messing

Kontaktoberfläche

Ni, Au / Sn

Kontaktwiderstand

40mΩ max

Isolationswiderstand

10¹²Ω Min

Strombelastbarkeit

2A

Betriebstemperatur

-55°C - +125°C

Betriebsspannung

250V AC

Prüfspannung

1000V AC

Verpackung

Blisterverpackung

Insulator material

PBT, UL94V-0

Contact material

Brass

Plating

Ni, Au / Sn

Contact resistance

40mΩ max

Insulation resistance

10¹²Ω min

Current rating

2A

Operating temperature

-55°C to +125°C

Operating voltage

250V AC

Test voltage

1000V AC

Packing

Tray packing

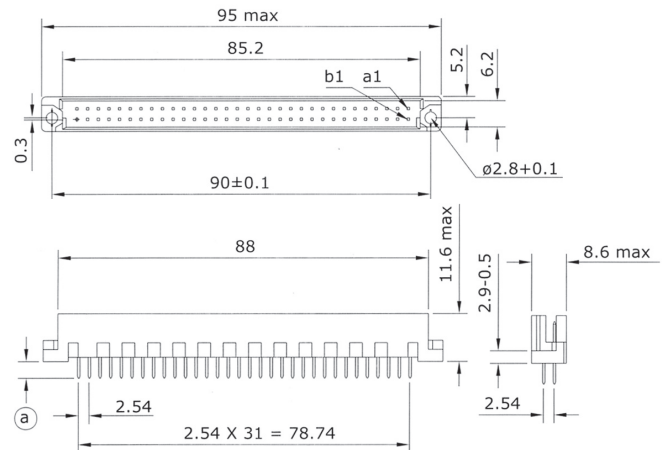
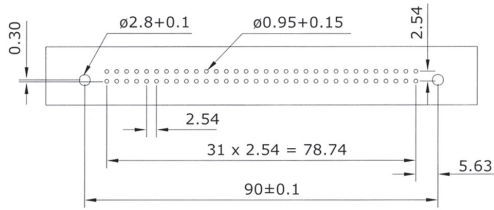

Bestellcode / Ordercode

Bestückung

64ab* / 32a / 32ab* / 16a

Positions loaded

64ab* / 32a / 32ab* / 16a

Pinlänge a

- T - 4.0mm* (0.30 x 0.38)
- T2.5 - 2.5mm* (0.30 x 0.38)
- WAB - 13.0mm* (0.60 x 0.60)
- WBB - 17.0mm (0.60 x 0.60)
- W5 - 5.0mm (0.60 x 0.60)
- W7 - 7.4mm (0.60 x 0.60)

Tail length a

- T - 4.0mm* (0.30 x 0.38)
- T2.5 - 2.5mm* (0.30 x 0.38)
- WAB - 13.0mm* (0.60 x 0.60)
- WBB - 17.0mm (0.60 x 0.60)
- W5 - 5.0mm (0.60 x 0.60)
- W7 - 7.4mm (0.60 x 0.60)

Gütestufe

- - Stufe 3
- 2 - Stufe 2
- 1 - Stufe 1

Quality class

- - Class 3 *
- 2 - Class 2
- 1 - Class 1

A - Q M x x - x

Bitte „x“ durch die geeignete Option ersetzen
 Please replace „x“ with appropriate option

* Standard

Isolierkörpermaterial
PBT, UL94V-0

Kontaktmaterial
Messing

Kontaktfläche
Ni, Au / Sn

Kontaktwiderstand
40mΩ max

Isolationswiderstand
10¹²Ω Min

Strombelastbarkeit
2A

Betriebstemperatur
-55°C - +125°C

Betriebsspannung
250V AC

Prüfspannung
1000V AC

Verpackung
Blisterverpackung

Insulator material
PBT, UL94V-0

Contact material
Brass

Plating
Ni, Au / Sn

Contact resistance
40mΩ max

Insulation resistance
10¹²Ω min

Current rating
2A

Operating temperature
-55°C to +125°C

Operating voltage
250V AC

Test voltage
1000V AC

Packing
Tray packing

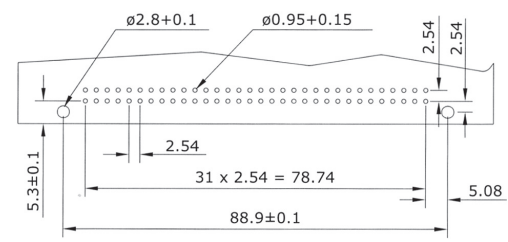
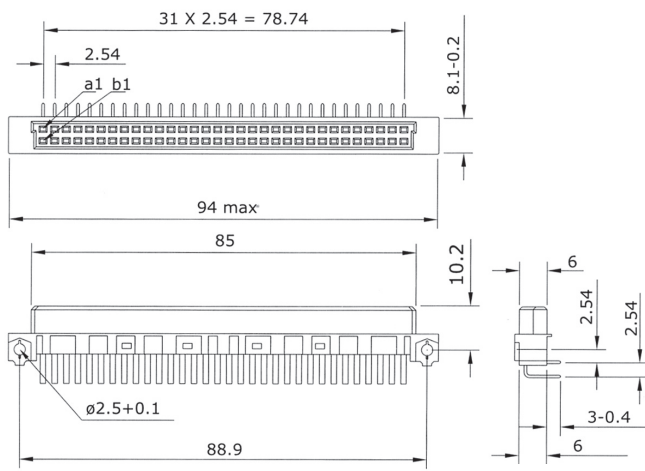
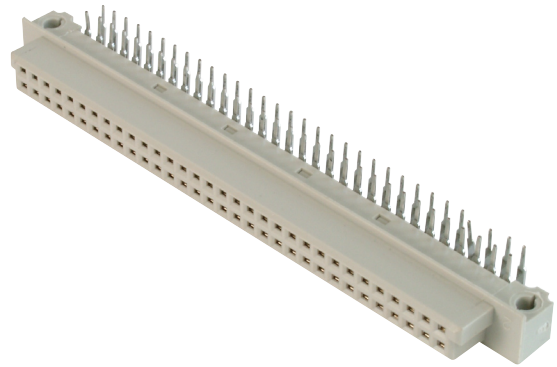

Bestellcode / Ordercode

Bestückung
64ab* / 32a / 32ab* / 16a

Ausführung, Pinlänge
R - abgewinkelt, 3mm(0.6x0.6)

Gütestufe
- - Stufe 3 *
2 - Stufe 2
1 - Stufe 1

Positions loaded
64ab* / 32a / 32ab* / 16a

Version, tail length
R - right-angled, 3mm(0.6x0.6)

Quality class
- - Class 3 *
2 - Class 2
1 - Class 1

A - Q F x R - x

Bitte „x“ durch die geeignete Option ersetzen
 Please replace „x“ with appropriate option

* Standard

- Cable assemblies
- D-Sub / Hoods Centronics
- Multiflex - DIN41651
- Modular
- USB IEEE1394
- Switches
- Powercords Powernets
- DIN41612 Hardmetric
- MiniDIN
- Sockets / Strips Jumper
- Terminal Blocks
- Memory Card
- FFC / FPC

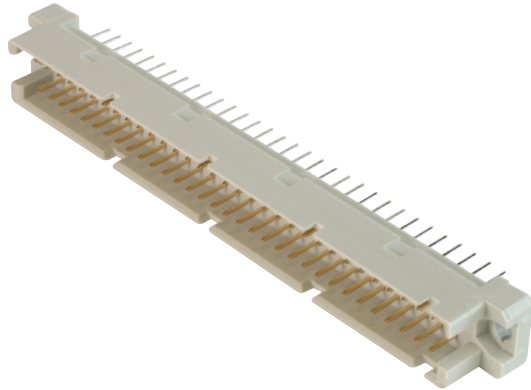

Isolierkörpermaterial
PBT, UL94V-0

Kontaktmaterial
Messing

Kontaktoberfläche
Ni, Au / Sn

Kontaktwiderstand
40mΩ max

Isolationswiderstand
10¹²Ω Min

Strombelastbarkeit
2A

Betriebstemperatur
-55°C - +125°C

Betriebsspannung
250V AC

Prüfspannung
1000V AC

Verpackung
Blisterverpackung

Insulator material
PBT, UL94V-0

Contact material
Brass

Plating
Ni, Au / Sn

Contact resistance
40mΩ max

Insulation resistance
10¹²Ω min

Current rating
2A

Operating temperature
-55°C to +125°C

Operating voltage
250V AC

Test voltage
1000V AC

Packing
Tray packing

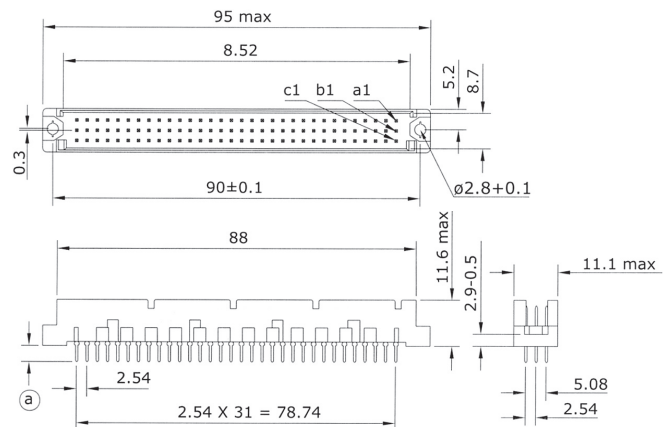
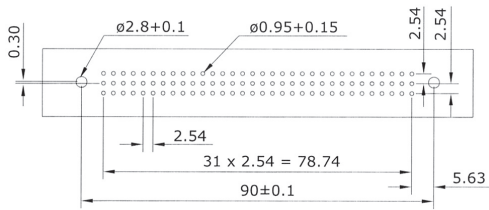

Bestellcode / Ordercode

Bestückung

64ab* / 32a / 32ab* / 16a

Positions loaded

64ab* / 32a / 32ab* / 16a

Pinlänge a

T - 4.0mm* (0.30 x 0.38)
 T2.5 - 2.5mm* (0.30 x 0.38)
 WAB - 13.0mm* (0.60 x 0.60)
 WBB - 17.0mm (0.60 x 0.60)
 W5 - 5.0mm (0.60 x 0.60)
 W7 - 7.4mm (0.60 x 0.60)

Tail length a

T - 4.0mm* (0.30 x 0.38)
 T2.5 - 2.5mm* (0.30 x 0.38)
 WAB - 13.0mm* (0.60 x 0.60)
 WBB - 17.0mm (0.60 x 0.60)
 W5 - 5.0mm (0.60 x 0.60)
 W7 - 7.4mm (0.60 x 0.60)

Gütestufe

- - Stufe 3
 2 - Stufe 2
 1 - Stufe 1

Quality class

- - class 3*
 2 - class 2
 1 - class 1

A - R M x x - x

Bitte „x“ durch die geeignete Option ersetzen
 Please replace „x“ with appropriate option

* Standard

Isolierkörpermaterial

PBT, UL94V-0

Kontaktmaterial

Phosphorbronze

Kontaktfläche

Ni, Au / Sn

Kontaktwiderstand

40mΩ max

Isolationswiderstand

10¹²Ω Min

Strombelastbarkeit

2A

Betriebstemperatur

-55°C - +125°C

Betriebsspannung

250V AC

Prüfspannung

1000V AC

Verpackung

Blisterverpackung

Insulator material

PBT, UL94V-0

Contact material

Phosphor bronze

Plating

Ni, Au / Sn

Contact resistance

40mΩ max

Insulation resistance

10¹²Ω min

Current rating

2A

Operating temperature

-55°C to +125°C

Operating voltage

250V AC

Test voltage

1000V AC

Packing

Tray packing

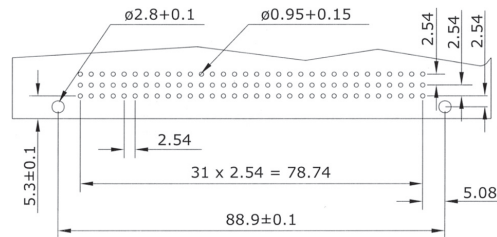
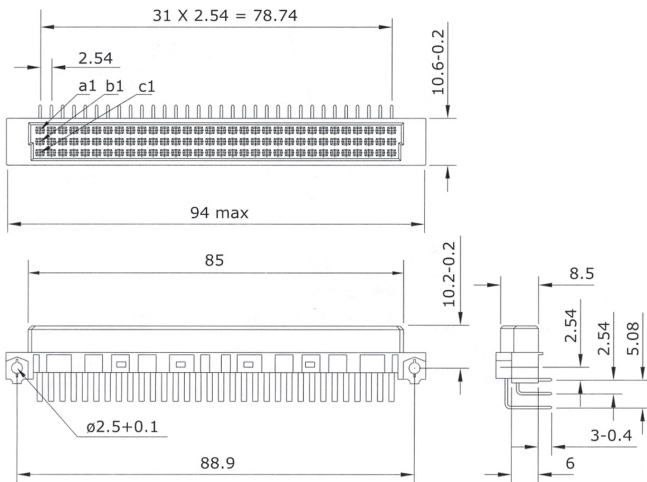
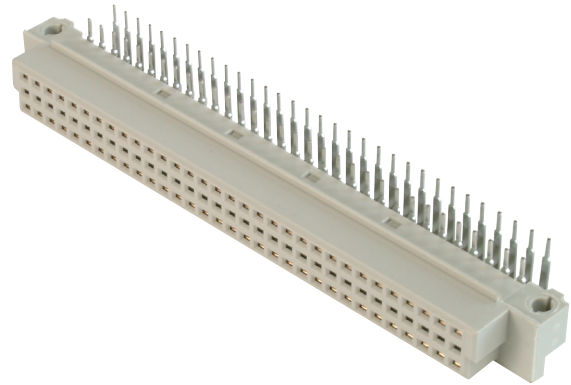

Bestellcode / Ordercode

Bestückung

96abc* / 64ac* / 64ab / 32a / 48abc / 32ac*

Position with contacts

96abc* / 64ac* / 64ab / 32a, 48abc / 32ac*

Ausführung, Pinlänge

R - abgewinkelt, 3mm(0.6x0.6)

Version, tail length

R - right-angled, 3mm(0.6x0.6)

Gütestufe

- - Stufe 3 *
 2 - Stufe 2
 1 - Stufe 1

Quality class

- - class 3 *
 2 - class 2
 1 - class 1

A - R F x R - x

Bitte „x“ durch die geeignete Option ersetzen
 Please replace „x“ with appropriate option

* Standard

- Cable assemblies
- D-Sub / Hoods Centronics
- Multiflex - DIN41651
- Modular
- USB IEEE1394
- Switches
- Powercards Powerinlets
- DIN41612 Hardmetric
- MiniDIN
- Sockets / Strips Jumper
- Terminal Blocks
- Memory Card
- FFC / FPC

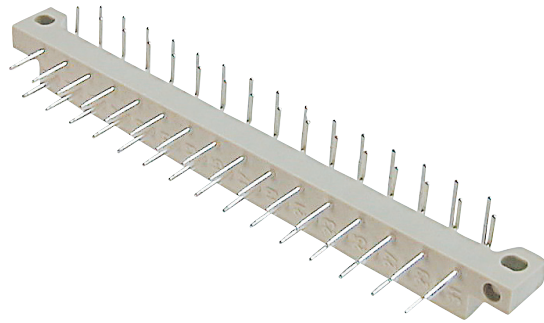

Isolierkörpermaterial
PC, UL94V-1

Kontaktmaterial
Messing

Kontaktoberfläche
Hartversilbert

Kontaktwiderstand
15mΩ max

Isolationswiderstand
10¹²mΩ Min

Strombelastbarkeit
2A

Betriebstemperatur
-55°C - +125°C

Betriebsspannung
250V AC

Prüfspannung
900V AC

Verpackung
Kartonbox

Insulator material
PC, UL94V-1

Contact material
Brass

Plating
Hard-silver-plated

Contact resistance
15mΩ max

Insulation resistance
10¹²Ω min

Current rating
2A

Operating temperature
-55°C to +125°C

Operating voltage
250V AC

Test voltage
900V AC

Packing
Carton box packing

Dimensions				
No. of contacts	A	B	C	D
13	45.6	30	30	40
21	65.6	50	50	60
31	90.6	75	75	85

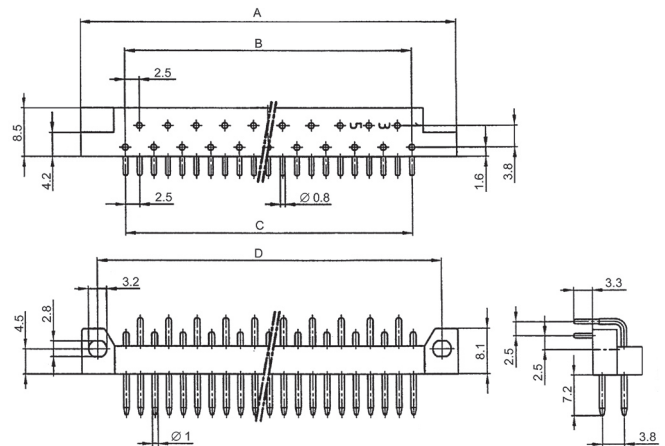
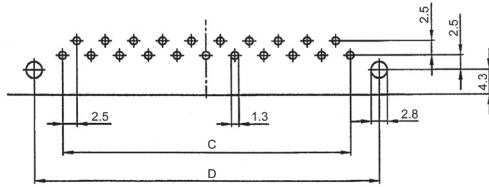

Bestellcode / Ordercode

Polzahl

13 / 21 / 31

No. of contacts

13 / 21 / 31

Ausführung, Pinlänge

S1 - abgewinkelt, 3.3mm(Ø0.80)

Version, tail length

S1 - right-angled, 3.3mm(Ø0.80)

A **xx** - **S1** / **SILVER**

Bitte „x“ durch die geeignete Option ersetzen
Please replace „x“ with appropriate option

Cable assemblies

D-Sub / Hoods Centronics

Multiflex - DIN41651

Modular

USB IEEE1394

Switches

Powercords Powerlets

DIN41612 Hardmetric

MiniDIN

Sockets / Strips Jumper

Terminal Blocks

Memory Card

FFC / FPC

Isolierkörpermaterial

PC, UL94V-1

Kontaktmaterial

Messing

Kontaktfläche

Hartversilbert

Kontaktwiderstand

15mΩ max

Isolationswiderstand

10¹²Ω Min

Strombelastbarkeit

2A

Betriebstemperatur

-55°C - +125°C

Betriebsspannung

250V AC

Prüfspannung

900V AC

Verpackung

Kartonbox

Insulator material

PC, UL94V-1

Contact material

brass

Plating

Hard-silver-plated

Contact resistance

15mΩ max

Insulation resistance

10¹²Ω min

Current rating

2A

Operating temperature

-55°C to +125°C

Operating voltage

250V AC

Test voltage

900V AC

Packing

carton box packing

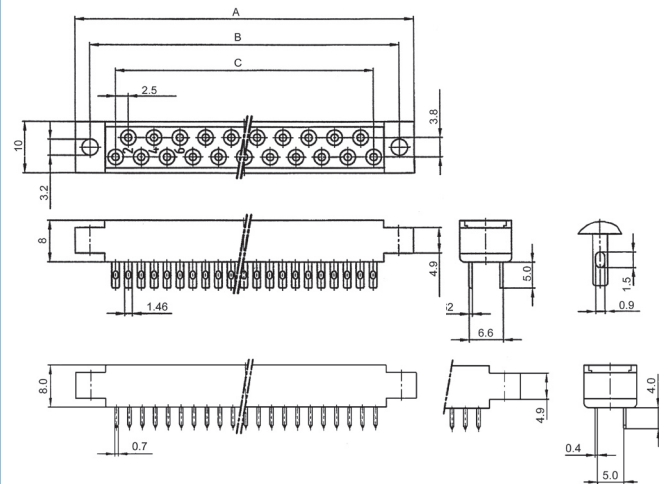
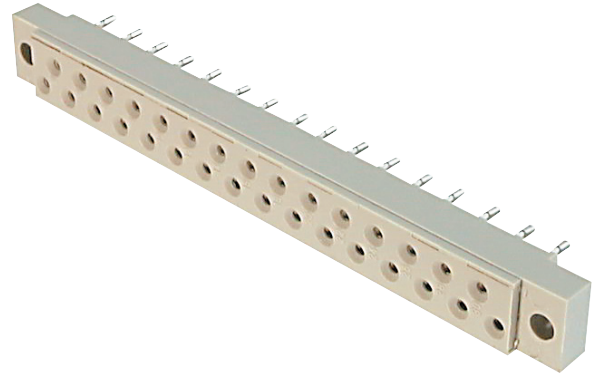

Dimensions				
No. of contacts	A	B	C	D
13	45.8	40	30	35
21	65.8	60	50	55
31	90.8	85	75	80

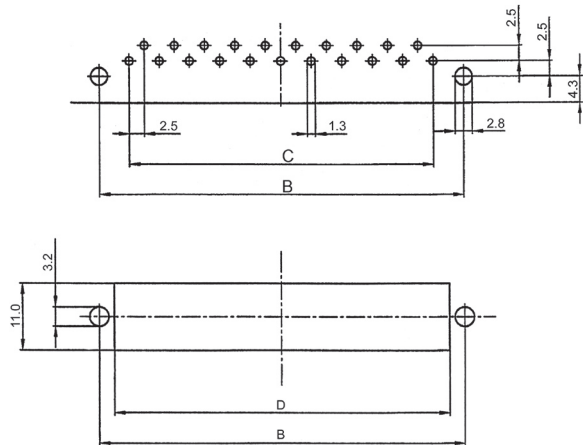

Bestellcode / Ordercode

Polzahl

13 / 21 / 31

No. of contacts

13 / 21 / 31

Ausführung, Pinlänge

S2 - Lötkelche
 L2 - Lötstifte, 4mm(0.40x0.70)

Version, tail length

S2 - Solder cups
 L2 - Solder pins, 4mm(0.40x0.70)

A - xx x / SILVER

Bitte „x“ durch die geeignete Option ersetzen
 Please replace „x“ with appropriate option

- Cable assemblies
- D-Sub / Hoods
Centronics
- Multiflex -
DIN41651
- Modular
- USB
IEEE1394
- Switches
- Powercards
Powerinlets
- DIN41612
Hardmetric
- MiniDIN
- Sockets / Strips
Jumper
- Terminal Blocks
- Memory Card
- FFC / FPC

Type A

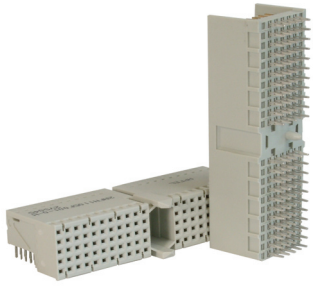

Type B

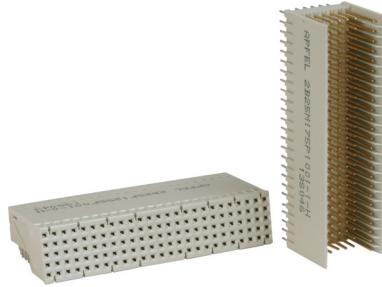

Type C

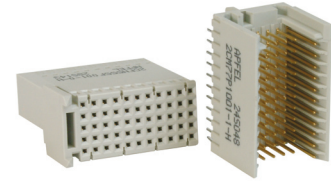

Type L

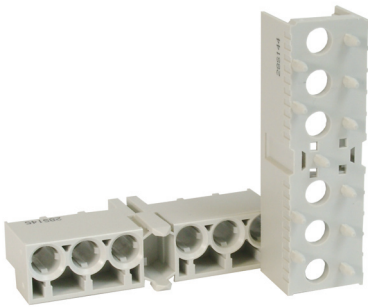

Type M

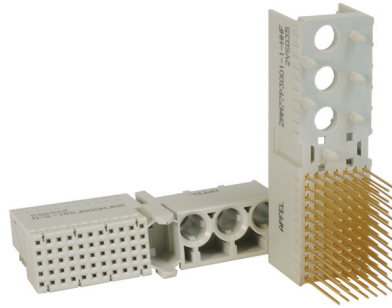

Type N



Rahmen / Shrouds

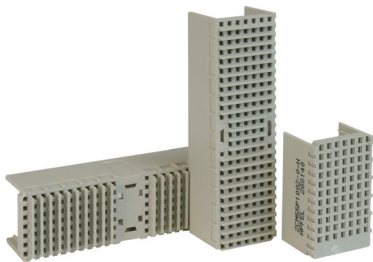

Kodierstifte / Coding Keys



Schirmbleche / Shielding Cover

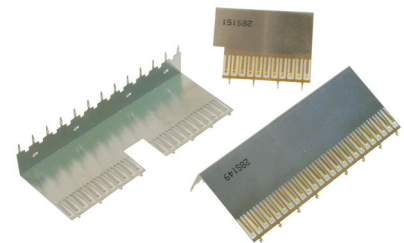

2.00mm Hard Metric Steckverbinder erfüllen die IEC 917 und IEC 61076-4-101

2.00mm Hard Metric connectors comply with international IEC 917 und IEC 61076-4-101

Cable
assemblies

D-Sub / Hoods
Centronics

Multiflex -
DIN41651

Modular

USB
IEEE1394

Switches

Powercords
Powerlets

DIN41612
Hardmetric

MiniDIN

Sockets / Strips
Jumper

Terminal Blocks

Memory Card

FFC / FPC

Isolierkörpermaterial

PBT, UL94V-0

Kontaktmaterial

Phosphorbronze

Kontaktfläche

Ni, Au / Sn

Kontaktwiderstand

20mΩ max

Isolationswiderstand

10⁴Ω max

Strombelastbarkeit

1A

Betriebstemperatur

-55°C - +125°C

Betriebsspannung

125V AC

Prüfspannung

750V AC

Verpackung

Stangenverpackung

Insulator material

PBT, UL94V-0

Contact material

Phosphor bronze

Plating

Ni, Au / Sn

Contact resistance

20mΩ max

Insulation resistance

10⁴Ω max

Current rating

1A

Operating temperature

-55°C - +125°C

Operating voltage

125V AC

Test voltage

750V AC

Packing

Tube packing

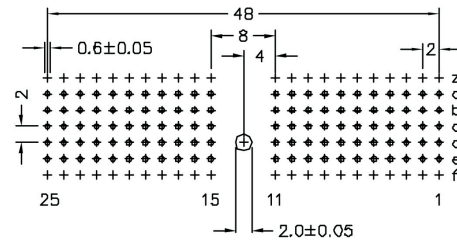
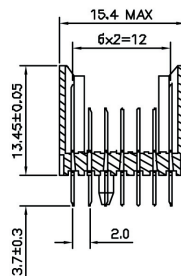
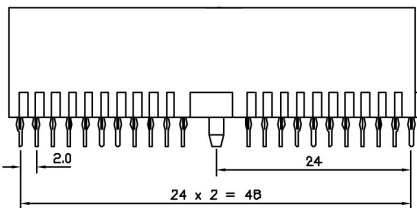
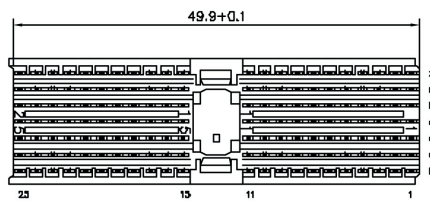
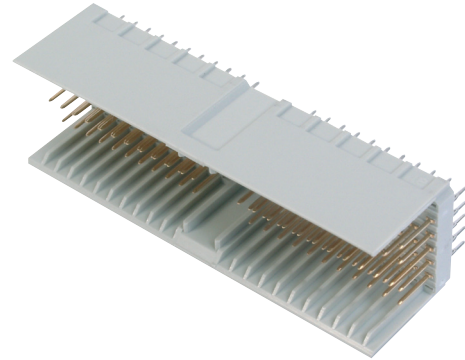

Detaillierter Bestellcode auf den Seiten 210 / 211
 Detailed ordercode see page 210 / 211

Cable assemblies

D-Sub / Hoods Centronics

Multiflex - DIN41651

Modular

USB IEEE1394

Switches

Powercards Powerinlets

DIN41612 Hardmetric

MiniDIN

Sockets / Strips Jumper

Terminal Blocks

Memory Card

FFC / FPC

- Cable assemblies
- D-Sub / Hoods Centronics
- Multiflex - DIN41651
- Modular
- USB IEEE1394
- Switches
- Powercords Powerleads
- DIN41612 Hardmetric
- MiniDIN
- Sockets / Strips Jumper
- Terminal Blocks
- Memory Card
- FFC / FPIC

Bestückungsplan
Assembly drawing

Polzahl
No. of contacts

Ausführung
Version

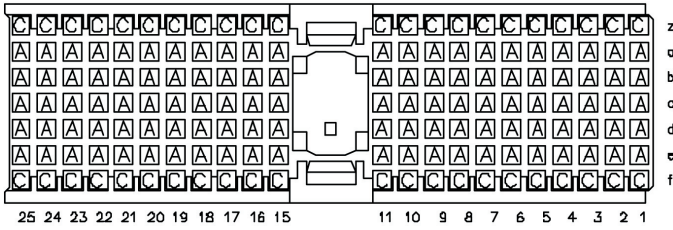

110

- z -
- a 1A
- b 1A
- c 1A
- d 1A
- e 1A
- f -

Bestellcode / [Ordercode](#)

A - 2AM110P1001 - 0 - H

Bestückungsplan
Assembly drawing

Polzahl
No. of contacts

Ausführung
Version

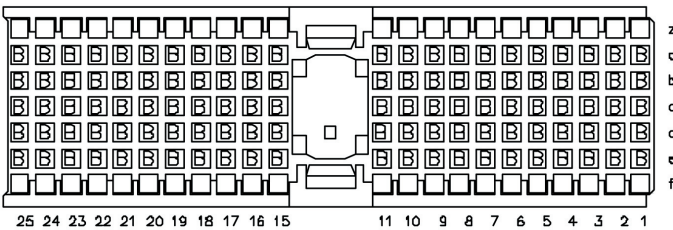

110

- z -
- a 1B
- b 1B
- c 1B
- d 1B
- e 1B
- f -

Bestellcode / [Ordercode](#)

A - 2AM110P1002 - 0 - H

Bestückungsplan
Assembly drawing

Polzahl
No. of contacts

Ausführung
Version

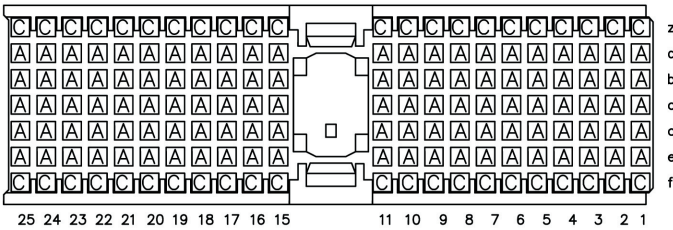

154

- z 1C
- a 1A
- b 1A
- c 1A
- d 1A
- e 1A
- f 1C

Bestellcode / [Ordercode](#)

A - 2AM110P1001 - 1 - H

Stiftoptionen / [Pin options](#)

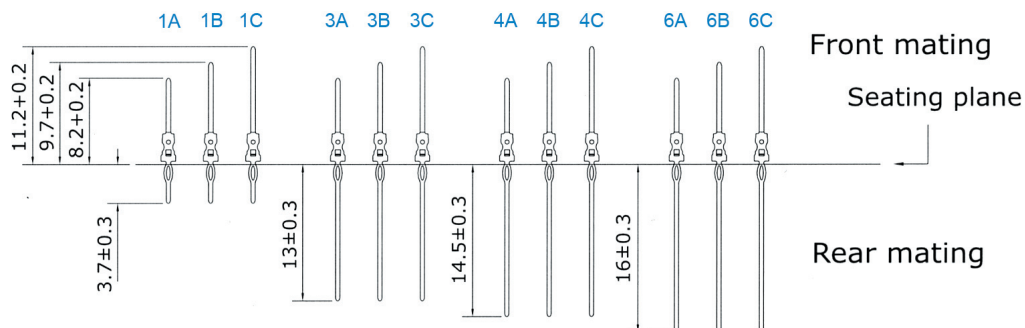

Bestückungsplan
Assembly drawing

Polzahl
No. of contacts

Ausführung
Version

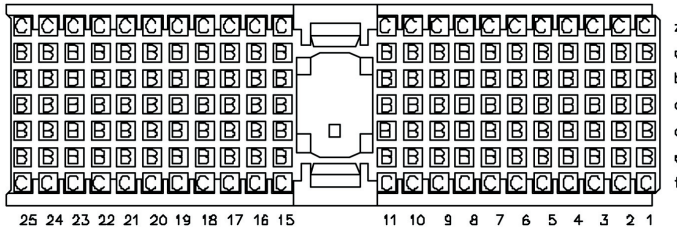

154

- z -
- a 1A
- b 1A
- c 1A
- d 1A
- e 1A
- f -

Bestellcode / [Ordercode](#)

A - 2AM154P1002 - 1 - H

Bestückungsplan
Assembly drawing

Polzahl
No. of contacts

Ausführung
Version

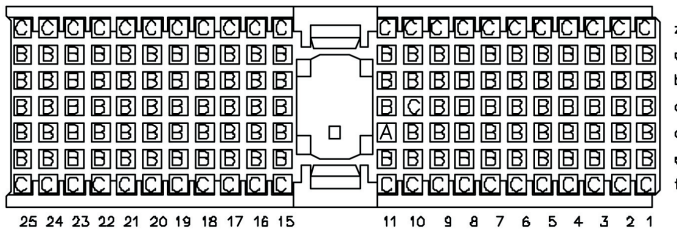

154

- z -
- a 1B
- b 1B
- c 1B
- d 1B
- e 1B
- f -

Bestellcode / [Ordercode](#)

A - 2AM154P1011 - 1 - H

Bestückungsplan
Assembly drawing

Polzahl
No. of contacts

Ausführung
Version

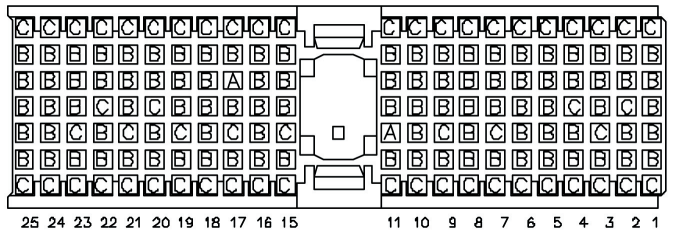

154

- z 1C
- a 1A
- b 1A
- c 1A
- d 1A
- e 1A
- f 1C

Bestellcode / [Ordercode](#)

A - 2AM154P1012 - 1 - H

Stiftoptionen / [Pin options](#)

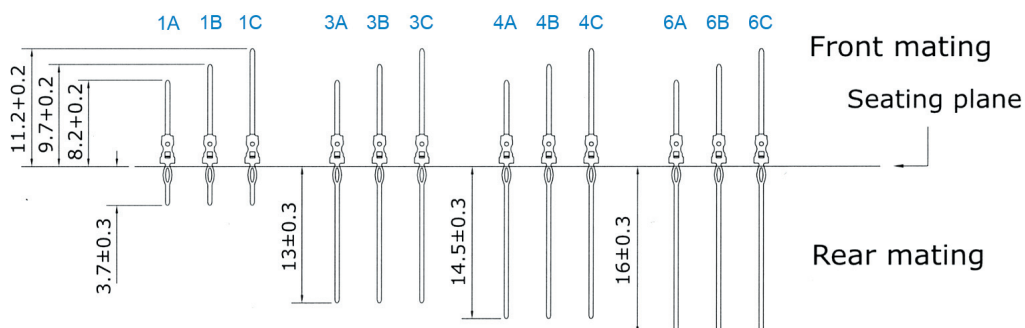

Cable assemblies

D-Sub / Hoods Centronics

Multiflex - DIN41651

Modular

USB IEEE1394

Switches

Powercords Powernets

DIN41612 Hardmetric

MiniDIN

Sockets / Strips Jumper

Terminal Blocks

Memory Card

FFC / FPC

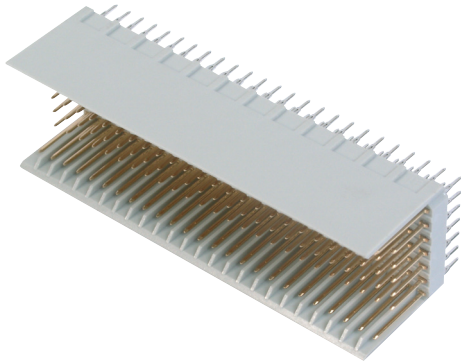

Isolierkörpermaterial

PBT, UL94V-0

Kontaktmaterial

Phosphorbronze

Kontaktoberfläche

Ni, Au / Sn

Kontaktwiderstand

20mΩ max

Isolationswiderstand

10⁴Ω min

Strombelastbarkeit

1A

Betriebstemperatur

-55°C - +125°C

Betriebsspannung

125V AC

Prüfspannung

750V AC

Verpackung

Stangenverpackung

Insulator material

PBT, UL94V-0

Contact material

Phosphor bronze

Plating

Ni, Au / Sn

Contact resistance

20mΩ max

Insulation resistance

10⁴Ω min

Current rating

1A

Operating temperature

-55°C to +125°C

Operating voltage

125V AC

Test voltage

750V AC

Packing

Tube packing

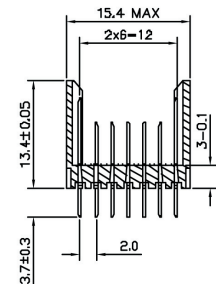
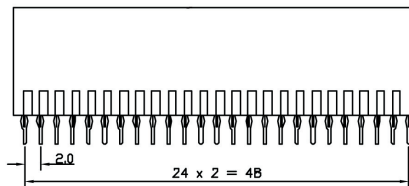
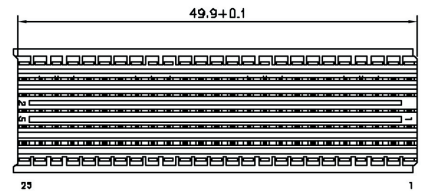
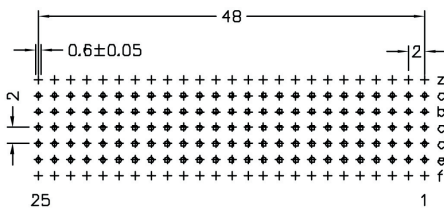

Detaillierter Bestellcode auf den Seite 213
 Detailed ordercode see page 213

- Cable assemblies
- D-Sub / Hoods Centronics
- Multiflex - DIN41691
- Modular
- USB IEEE1394
- Switches
- Powercords Powerlets
- DIN41612 Hardmetric
- MiniDIN
- Sockets / Strips Jumper
- Terminal Blocks
- Memory Card
- FFC / FPC

Bestückungsplan
Assembly drawing

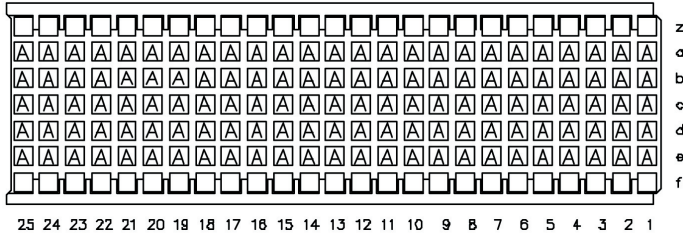

Polzahl
No. of contacts

125

Ausführung
Version

z -
a 1A
b 1A
c 1A
d 1A
e 1A
f -

Bestellcode / Ordercode

A - 2B25M125P1001 - 0 - H

Bestückungsplan
Assembly drawing

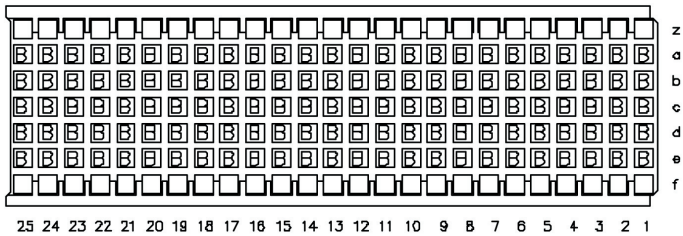

Polzahl
No. of contacts

125

Ausführung
Version

z -
a 1B
b 1B
c 1B
d 1B
e 1B
f -

Bestellcode / Ordercode

A - 2B23M125P1002 - 0 - H

Bestückungsplan
Assembly drawing

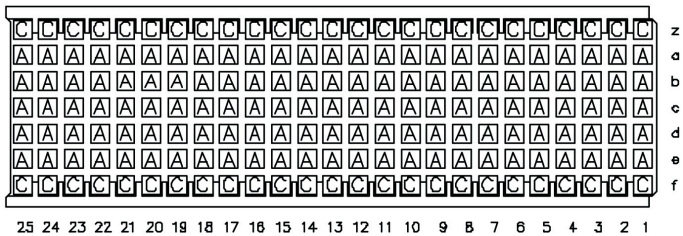

Polzahl
No. of contacts

154

Ausführung
Version

z 1C
a 1A
b 1A
c 1A
d 1A
e 1A
f 1C

Bestellcode / Ordercode

A - 2B25M175P1001 - 1 - H

Stiftoptionen / Pin options

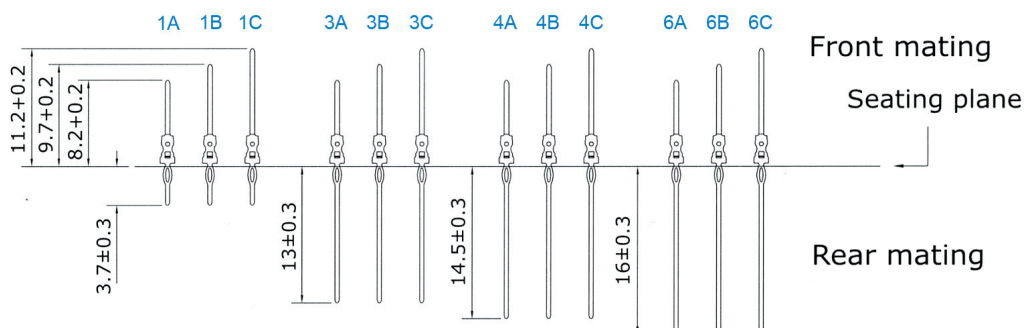

- Cable assemblies
- D-Sub / Hoods Centronics
- Multiflex - DIN41651
- Modular
- USB IEEE1394
- Switches
- Powercards Powerinlets
- DIN41612 Hardmetric
- MiniDIN
- Sockets / Strips Jumper
- Terminal Blocks
- Memory Card
- FFC / FPC

Cable
assemblies

D-Sub / Hoods
Centronics

Multiflex -
DIN41651

Modular

USB
IEEE1394

Switches

Powercords
Powerlets

DIN41612
Hardmetric

MiniDIN

Sockets / Strips
Jumper

Terminal Blocks

Memory Card

FFC / FPC

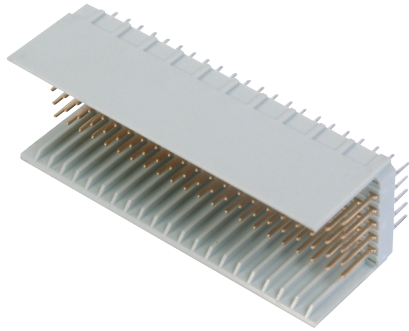

Isolierkörpermaterial
PBT, UL94V-0

Kontaktmaterial
Phosphorbronze

Kontaktoberfläche
Ni, Au / Sn

Kontaktwiderstand
20mΩ max

Isolationswiderstand
10⁴Ω min

Strombelastbarkeit
1A

Betriebstemperatur
-55°C - +125°C

Betriebsspannung
125V AC

Prüfspannung
750V AC

Verpackung
Stangenverpackung

Insulator material
PBT, UL94V-0

Contact material
Phosphor bronze

Plating
Ni, Au / Sn

Contact resistance
20mΩ max

Insulation resistance
10⁴Ω min

Current rating
1A

Operating temperature
-55°C to +125°C

Operating voltage
125V AC

Test voltage
750V AC

Packing
Tube packing

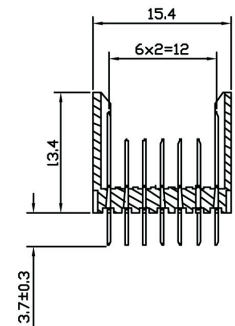
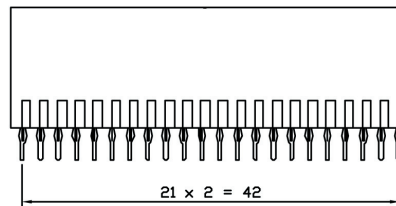
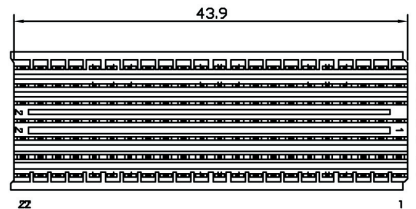
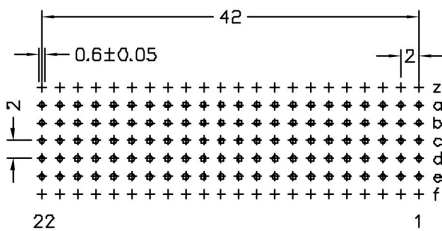

Detaillierter Bestellcode auf den Seite 215
 Detailed ordercode see page 215

Bestückungsplan
Assembly drawing

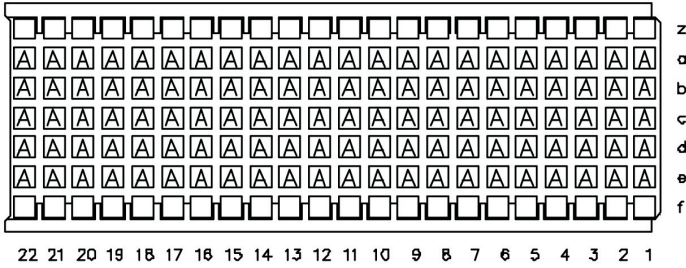

Polzahl
No. of contacts

110

Ausführung
Version

- z -
- a 1A
- b 1A
- c 1A
- d 1A
- e 1A
- f -

Bestellcode / [Ordercode](#)

A - 2B22M110P1001 - 0 - H

Bestückungsplan
Assembly drawing

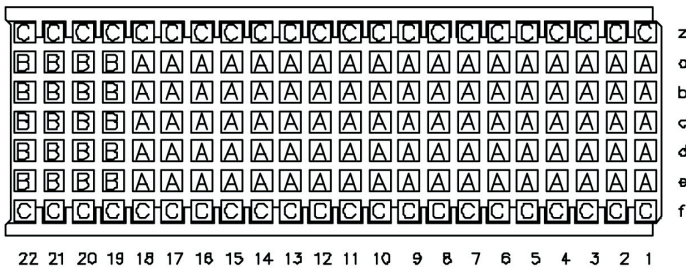

Polzahl
No. of contacts

110

Ausführung
Version

- z -
- a 1B
- b 1B
- c 1B
- d 1B
- e 1B
- f -

Bestellcode / [Ordercode](#)

A - 2B22M110P1002 - 0 - H

Bestückungsplan
Assembly drawing

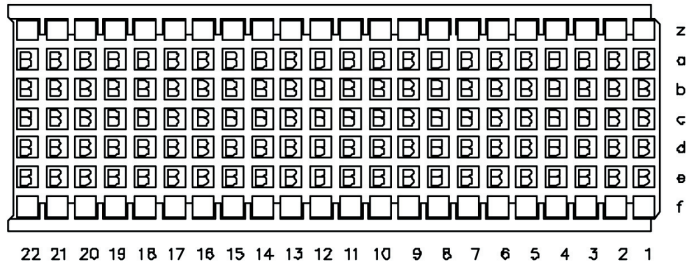

Polzahl
No. of contacts

154

Ausführung
Version

- z 1C
- a 1A
- b 1A
- c 1A
- d 1A
- e 1A
- f 1C

Bestellcode / [Ordercode](#)

A - 2B22M154P1013 - 1 - H

Stiftoptionen / [Pin options](#)

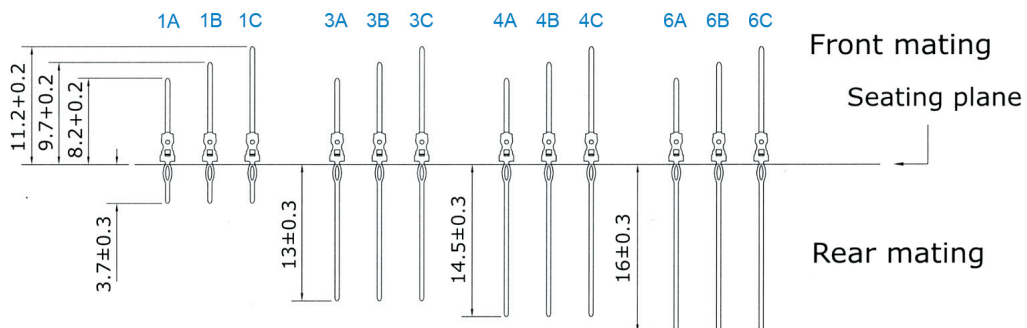

- Cable assemblies
- D-Sub / Hoods Centronics
- Multiflex - DIN41651
- Modular
- USB IEEE1394
- Switches
- Powercords Powernets
- DIN41612 Hardmetric
- MiniDIN
- Sockets / Strips Jumper
- Terminal Blocks
- Memory Card
- FFC / FPC

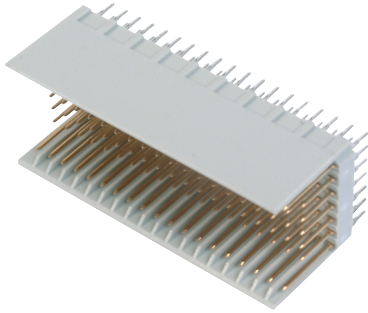

Isolierkörpermaterial

PBT, UL94V-0

Kontaktmaterial

Phosphorbronze

Kontaktoberfläche

Ni, Au / Sn

Kontaktwiderstand

20mΩ max

Isolationswiderstand

10⁴Ω min

Strombelastbarkeit

1A

Betriebstemperatur

-55°C - +125°C

Betriebsspannung

125V AC

Prüfspannung

750V AC

Verpackung

Stangenverpackung

Insulator material

PBT, UL94V-0

Contact material

Phosphor bronze

Plating

Ni, Au / Sn

Contact resistance

20mΩ max

Insulation resistance

10⁴Ω min

Current rating

1A

Operating temperature

-55°C to +125°C

Operating voltage

125V AC

Test voltage

750V AC

Packing

Tube packing

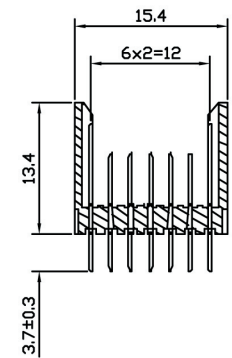
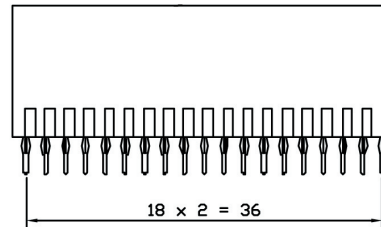
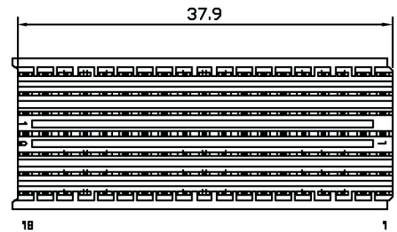
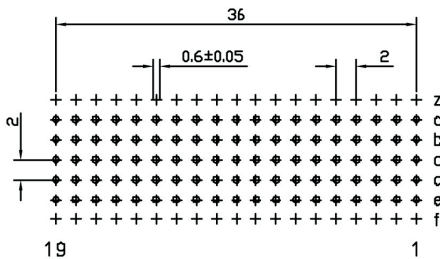

Detaillierter Bestellcode auf den Seite 217
 Detailed ordercode see page 217

Cable
assemblies

D-Sub / Hoods
Centronics

Multiflex -
DIN41651

Modular

USB
IEEE1394

Switches

Powercords
Powerlets

DIN41612
Hardmetric

MiniDIN

Sockets / Strips
Jumper

Terminal Blocks

Memory Card

FFC / FPC

Bestückungsplan
Assembly drawing

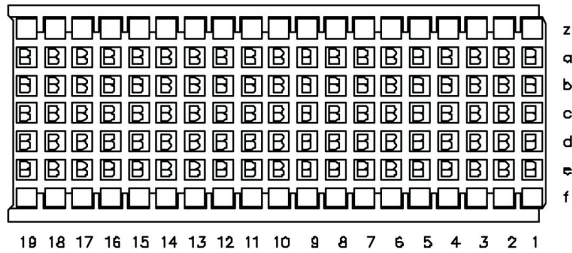

Polzahl
No. of contacts

95

Ausführung
Version

- z -
- a 1A
- b 1A
- c 1A
- d 1A
- e 1A
- f -

Bestellcode / Ordercode

A - 2B19M95P1001 - 0 - H

Bestückungsplan
Assembly drawing

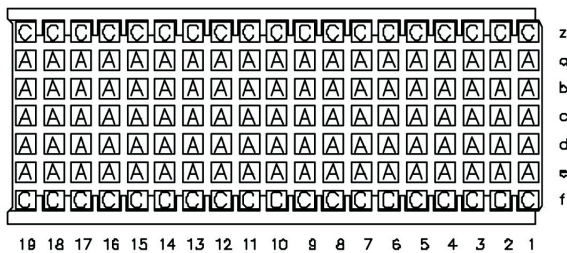

Polzahl
No. of contacts

95

Ausführung
Version

- z -
- a 1B
- b 1B
- c 1B
- d 1B
- e 1B
- f -

Bestellcode / Ordercode

A - 2B19M95P1002 - 0 - H

Bestückungsplan
Assembly drawing

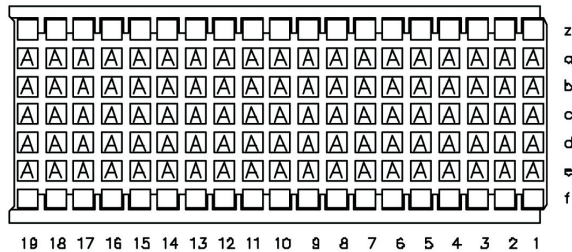

Polzahl
No. of contacts

133

Ausführung
Version

- z 1C
- a 1A
- b 1A
- c 1A
- d 1A
- e 1A
- f 1C

Bestellcode / Ordercode

A - 2B19M133P1001 - 1 - H

Stiftoptionen / Pin options

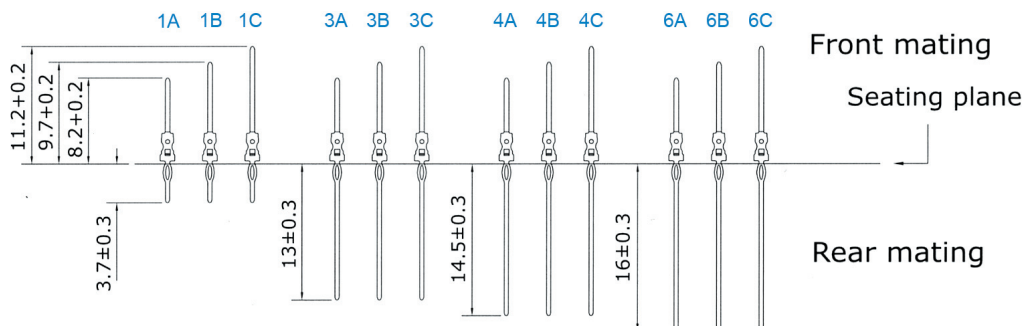

- Cable assemblies
- D-Sub / Hoods Centronics
- Multiflex - DIN41651
- Modular
- USB IEEE1394
- Switches
- Powercords Powernets
- DIN41612 Hardmetric
- MiniDIN
- Sockets / Strips Jumper
- Terminal Blocks
- Memory Card
- FFC / FPC

- Cable assemblies
- D-Sub / Hoods Centronics
- Multiflex - DIN41651
- Modular
- USB IEEE1394
- Switches
- Powercords Powerlets
- DIN41612 Hardmetric
- MiniDIN
- Sockets / Strips Jumper
- Terminal Blocks
- Memory Card
- FFC / FPC

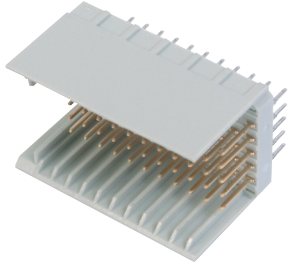

Isolierkörpermaterial
PBT, UL94V-0

Kontaktmaterial
Phosphorbronze

Kontaktoberfläche
Ni, Au / Sn

Kontaktwiderstand
20mΩ max

Isolationswiderstand
10⁴Ω min

Strombelastbarkeit
1A

Betriebstemperatur
-55°C - +125°C

Betriebsspannung
125V AC

Prüfspannung
750V AC

Verpackung
Stangenverpackung

Insulator material
PBT, UL94V-0

Contact material
Phosphor bronze

Plating
Ni, Au / Sn

Contact resistance
20mΩ max

Insulation resistance
10⁴Ω min

Current rating
1A

Operating temperature
-55°C to +125°C

Operating voltage
125V AC

Test voltage
750V AC

Packing
Tube packing

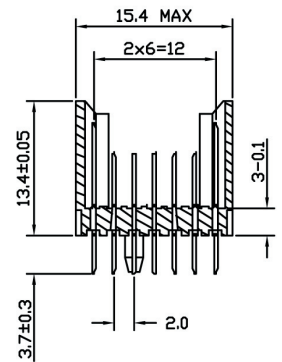
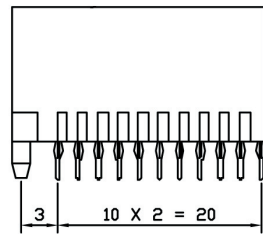
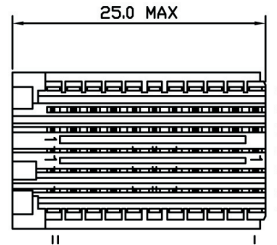
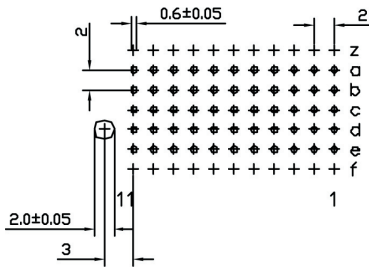

Detaillierter Bestellcode auf den Seite 219
 Detailed ordercode see page 219

Bestückungsplan
Assembly drawing

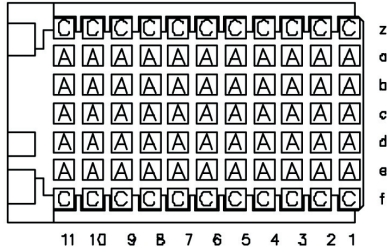

Polzahl
No. of contacts

55

Ausführung
Version

z -
 a 1A
 b 1A
 c 1A
 d 1A
 e 1A
 f -

Bestellcode / Ordercode

A - 2CM55P1001 - 0 - H

Bestückungsplan
Assembly drawing

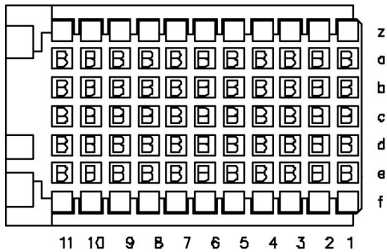

Polzahl
No. of contacts

55

Ausführung
Version

z -
 a 1B
 b 1B
 c 1B
 d 1B
 e 1B
 f -

Bestellcode / Ordercode

A - 2CM55P1002 - 0 - H

Bestückungsplan
Assembly drawing

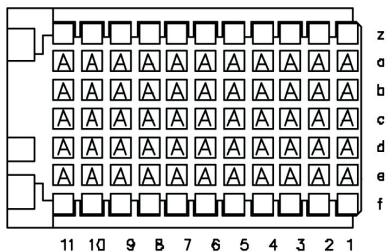

Polzahl
No. of contacts

77

Ausführung
Version

z 1C
 a 1A
 b 1A
 c 1A
 d 1A
 e 1A
 f 1C

Bestellcode / Ordercode

A - 2CM77P1001 - 1 - H

Stiftoptionen / Pin options

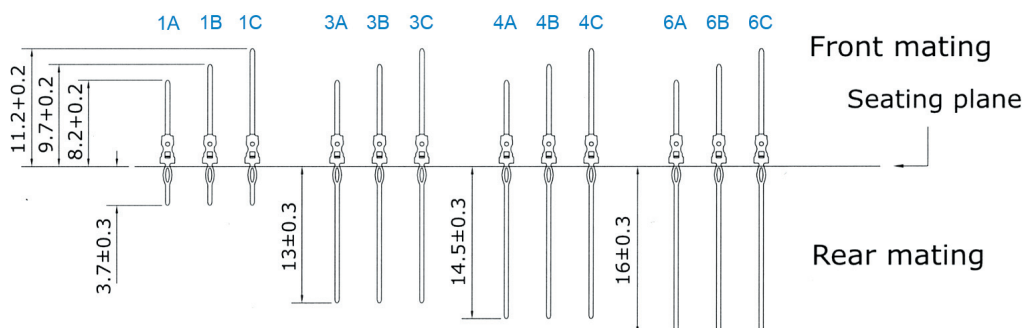

- Cable assemblies
- D-Sub / Hoods Centronics
- Multiflex - DIN41651
- Modular
- USB IEEE1394
- Switches
- Powercards Powerinlets
- DIN41612 Hardmetric
- MiniDIN
- Sockets / Strips Jumper
- Terminal Blocks
- Memory Card
- FFC / FPC

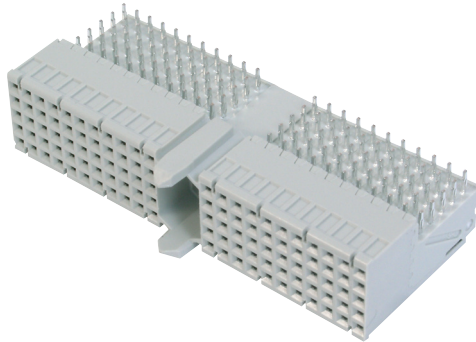

Isolierkörpermaterial
PBT, UL94V-0

Kontaktmaterial
Phosphorbronze

Kontaktfläche
Ni, Au / Sn

Kontaktwiderstand
20mΩ max

Isolationswiderstand
10⁴Ω min

Strombelastbarkeit
1A

Betriebstemperatur
-55°C - +125°C

Betriebsspannung
125V AC

Prüfspannung
750V AC

Verpackung
Stangenverpackung

Insulator material
PBT, UL94V-0

Contact material
Phosphor bronze

Plating
Ni, Au / Sn

Contact resistance
20mΩ max

Insulation resistance
10⁴Ω min

Current rating
1A

Operating temperature
-55°C to +125°C

Operating voltage
125V AC

Test voltage
750V AC

Packing
Tube packing

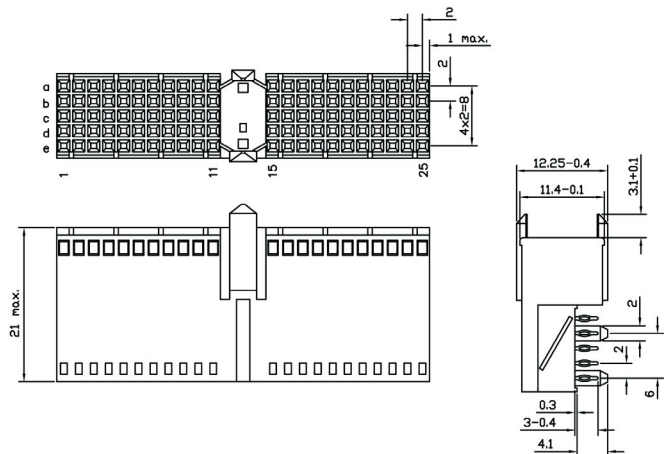
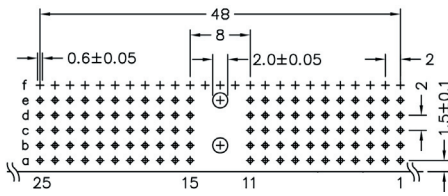

Bestellcode / Ordercode

A - 2AF1105F001 - 0 - H

Cable
assemblies

D-Sub / Hoods
Centronics

Multiflex -
DIN41651

Modular

USB
IEEE1394

Switches

Powercords
Powerlets

DIN41612
Hardmetric

MiniDIN

Sockets / Strips
Jumper

Terminal Blocks

Memory Card

FFC / FPC

Isolierkörpermaterial
 PBT, UL94V-0

Kontaktmaterial
 Phosphorbronze

Kontaktfläche
 Ni, Au / Sn

Kontaktwiderstand
 20mΩ max

Isolationswiderstand
 10⁴Ω max

Strombelastbarkeit
 1A

Betriebstemperatur
 -55°C - +125°C

Betriebsspannung
 125V AC

Prüfspannung
 750V AC

Verpackung
 Stangenverpackung

Insulator material
 PBT, UL94V-0

Contact material
 Phosphor bronze

Plating
 Ni, Au / Sn

Contact resistance
 20mΩ max

Insulation resistance
 10⁴Ω max

Current rating
 1A

Operating temperature
 -55°C - +125°C

Operating voltage
 125V AC

Test voltage
 750V AC

Packing
 Tube packing

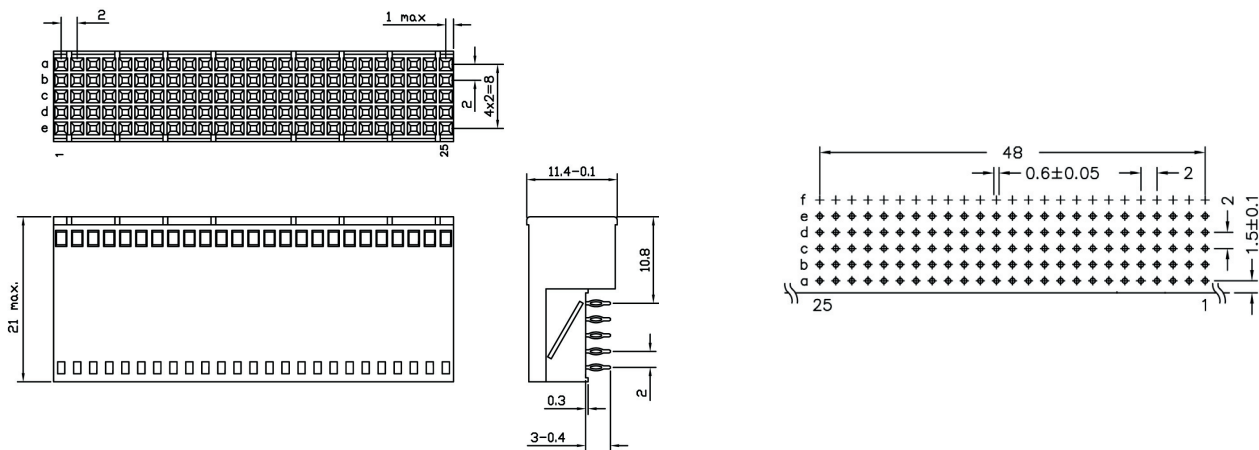
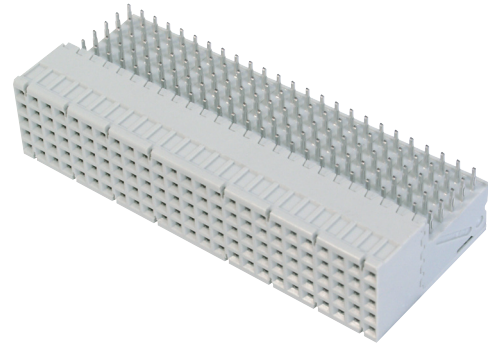

Bestellcode / [Ordercode](#)

A - 2B25F1255F001 - 0 - H

Cable assemblies

D-Sub / Hoods
 Centronics

Multiflex -
 DIN41691

Modular

USB
 IEEE1394

Switches

Powercards
 Powerinlets

DIN41612
 Hardmetric

MiniDIN

Sockets / Strips
 Jumper

Terminal Blocks

Memory Card

FFC / FPC

- Cable assemblies
- D-Sub / Hoods Centronics
- Multiflex - DIN41651
- Modular
- USB IEEE1394
- Switches
- Powercords Powerlets
- DIN41612 Hardmetric
- MiniDIN
- Sockets / Strips Jumper
- Terminal Blocks
- Memory Card
- FFC / FPC

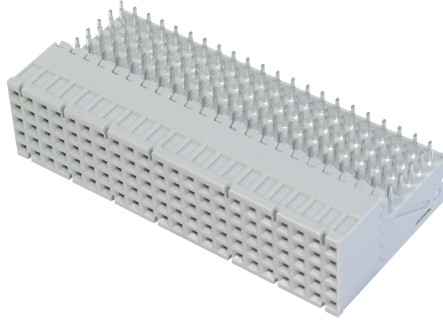

Isolierkörpermaterial
PBT, UL94V-0

Kontaktmaterial
Phosphorbronze

Kontaktoberfläche
Ni, Au / Sn

Kontaktwiderstand
20mΩ max

Isolationswiderstand
10⁴Ω min

Strombelastbarkeit
1A

Betriebstemperatur
-55°C - +125°C

Betriebsspannung
125V AC

Prüfspannung
750V AC

Verpackung
Stangenverpackung

Insulator material
PBT, UL94V-0

Contact material
Phosphor bronze

Plating
Ni, Au / Sn

Contact resistance
20mΩ max

Insulation resistance
10⁴Ω min

Current rating
1A

Operating temperature
-55°C to +125°C

Operating voltage
125V AC

Test voltage
750V AC

Packing
Tube packing

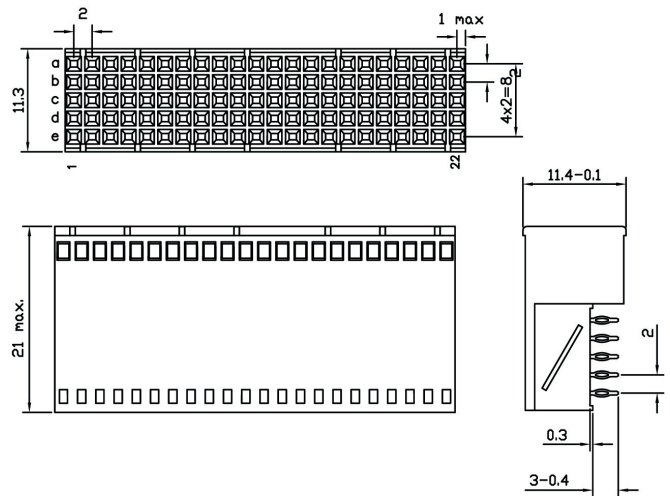
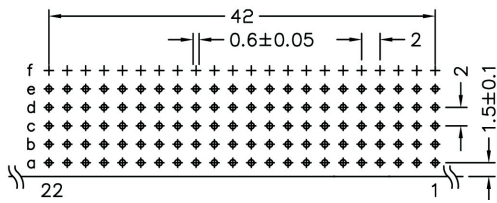

Bestellcode / Ordercode

A - 2B221105F001 - 0 - H

Isolierkörpermaterial
 PBT, UL94V-0

Kontaktmaterial
 Phosphorbronze

Kontaktfläche
 Ni, Au / Sn

Kontaktwiderstand
 20mΩ max

Isolationswiderstand
 10⁴Ω max

Strombelastbarkeit
 1A

Betriebstemperatur
 -55°C - +125°C

Betriebsspannung
 125V AC

Prüfspannung
 750V AC

Verpackung
 Stangenverpackung

Insulator material
 PBT, UL94V-0

Contact material
 Phosphor bronze

Plating
 Ni, Au / Sn

Contact resistance
 20mΩ max

Insulation resistance
 10⁴Ω max

Current rating
 1A

Operating temperature
 -55°C - +125°C

Operating voltage
 125V AC

Test voltage
 750V AC

Packing
 Tube packing

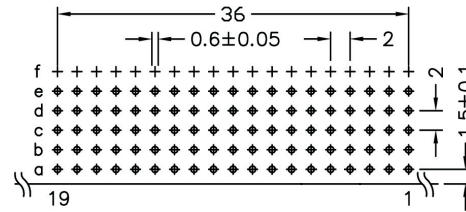
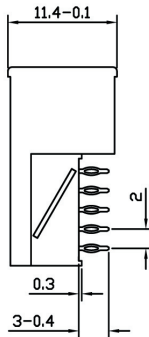
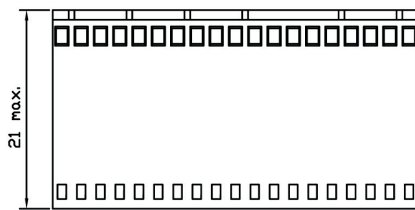
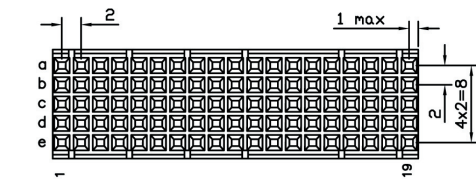
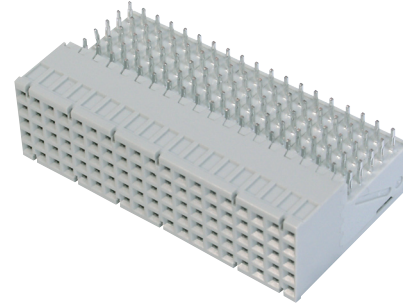

Bestellcode / Ordercode

A - 2B19F955F001 - 0 - H

Cable assemblies

D-Sub / Hoods Centronics

Multiflex - DIN41651

Modular

USB IEEE1394

Switches

Powercords Powerinlets

DIN41612 Hardmetric

MiniDIN

Sockets / Strips Jumper

Terminal Blocks

Memory Card

FFC / FPC

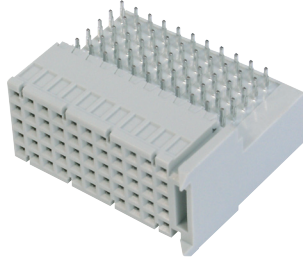

Isolierkörpermaterial

PBT, UL94V-0

Kontaktmaterial

Phosphorbronze

Kontaktoberfläche

Ni, Au / Sn

Kontaktwiderstand

20mΩ max

Isolationswiderstand

10⁴Ω min

Strombelastbarkeit

1A

Betriebstemperatur

-55°C - +125°C

Betriebsspannung

125V AC

Prüfspannung

750V AC

Verpackung

Stangenverpackung

Insulator material

PBT, UL94V-0

Contact material

Phosphor bronze

Plating

Ni, Au / Sn

Contact resistance

20mΩ max

Insulation resistance

10⁴Ω min

Current rating

1A

Operating temperature

-55°C to +125°C

Operating voltage

125V AC

Test voltage

750V AC

Packing

Tube packing

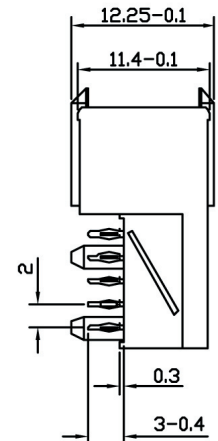
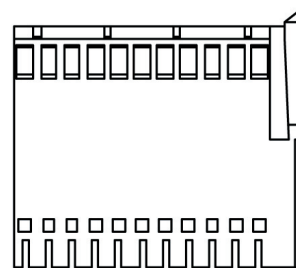
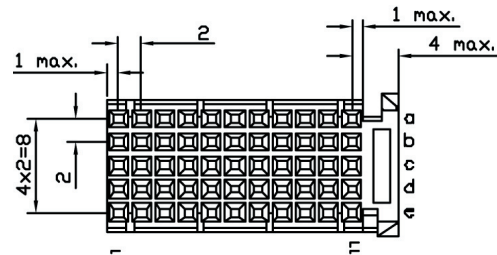
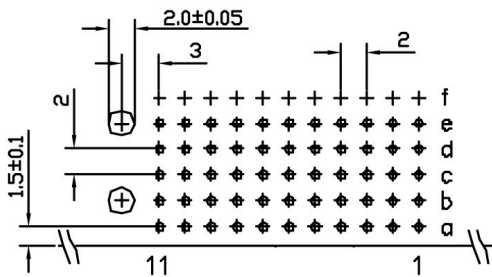

Bestellcode / Ordercode

A - 2CF555F001 - 0 - H

Cable assemblies

D-Sub / Hoods Centronics

Multiflex - DIN41651

Modular

USB IEEE1394

Switches

Powercords Powerlets

DIN41612 Hardmetric

MiniDIN

Sockets / Strips Jumper

Terminal Blocks

Memory Card

FFC / FPC

Firma / Company:	Tel:
Kontaktperson / Contact Name:	Fax:
Adresse / Adress:	E-Mail:
Mustermenge / Sample Qty:	Jahresbedarf / Annual demand:

Type-A Connector

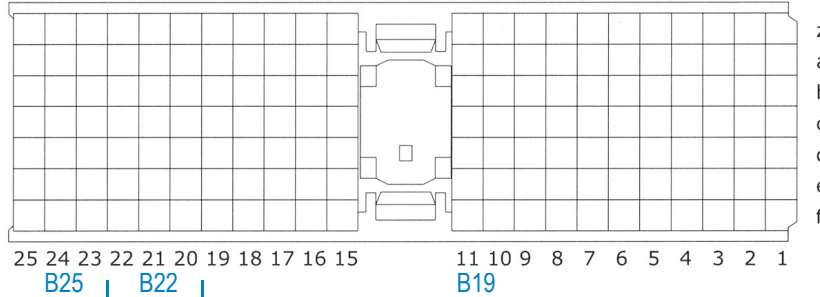

Type-B Connector

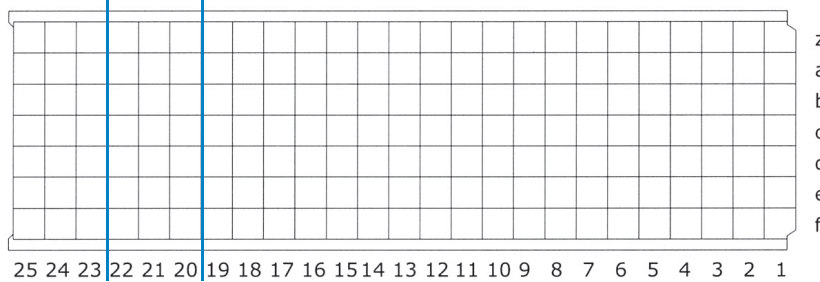

Type-C Connector

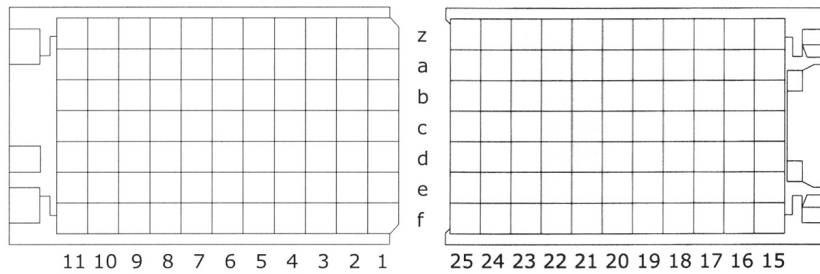

Type-M Connector

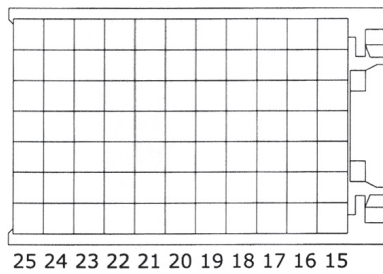

Plating options:

GF	G=0,38µm	H=0,76µm*	J=1µm	gold on contact area
----	----------	-----------	-------	----------------------

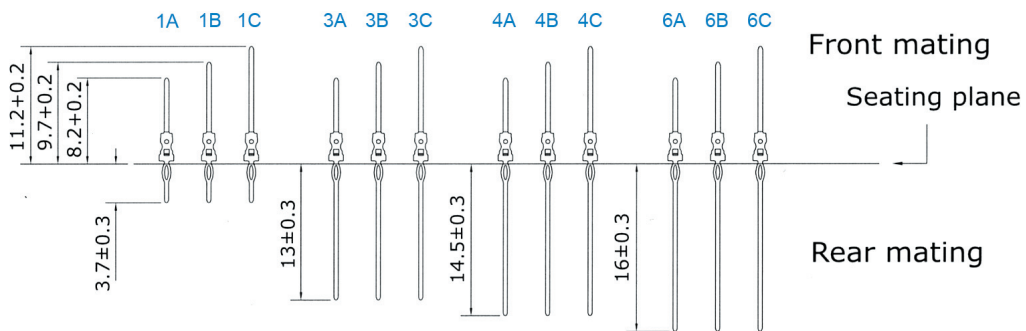

Bitte Tabelle auswählen und mit Code für Pinlänge vervollständigen. Vergütung der Pins durch markieren.
Please choose and complete tab with code for pinlength. Please mark plating with .

* Standard

- Cable assemblies
- D-Sub / Hoods Centronics
- Multiflex - DIN41651
- Modular
- USB IEEE1394
- Switches
- Powercords Powerinlets
- DIN41612 Hardmetric
- MiniDIN
- Sockets / Strips Jumper
- Terminal Blocks
- Memory Card
- FFC / FPC