

RoHS (Pb) TMOV® and iTMOV® Varistor Series

Description

The Littelfuse TMOV® and iTMOV® thermally protected varistors represent a new development in integrated circuit protection. Both versions are comprised of radial leaded MOVs (Metal Oxide Varistors) with an integrated thermally activated element designed to open in the event of overheating due to the abnormal overvoltage, limited current, conditions outlined in UL1449. The TMOV® and iTMOV® varistor's integrated thermal element, in conjunction with appropriate enclosure design, helps facilitate TVSS module compliance to UL1449 for both cord connected and permanently connected applications.

The TMOV® and iTMOV® varistors offer quick thermal response due to the close proximity of the integrated thermal element to the MOV body. The integrated configuration also offers lower inductance than most discrete solutions resulting in improved clamping performance to fast overvoltage transients.

The iTMOV® varistor differs from the TMOV® varistor by the inclusion of a third lead for the purpose of indicating that the MOV has been disconnected from the circuit. This lead facilitates connection to monitoring circuitry.

Additionally TMOV® and iTMOV® varistors are wave solderable, thus simplifying end product assembly by reducing the the expense and rework associated with hand soldering operations.

Agency Approvals

Agency Approval	Agency File Number	Standard		RoHS and Lead-free	
		14mm	20mm	14mm	20mm
UL1414	E56529	√	√	√	√
UL1449 ⁴	E75961	√	√ ¹	√	√
UL60691 (selected Tests)	E75961SP	N/A	√ ²	N/A	No.3
22.2-1	LR91788	√	√	Pending	Pending
IEC - CECC Spec	QC42201-X0001	√	√ ³	√	√
IEC - CECC Spec	40021525	√	√	√	√

1. Devices with ratings greater than 420VAC are not affected by these abnormal voltage conditions.

2. Regarding thermal cut-offs for ratings up to 420VAC.

3. Under evaluation

4. 'Compliant to UL1449 2nd Edition. 3rd edition pending'.

Accelerated Age Testing: Devices comply with Accelerated aging test requirements per ANSI/IEEE C62.11 and may be used in secondary surge arresters without repeating this test.

Applications

- TVSS Products
- AC Panel Protection Modules
- AC Line Power Supplies
- Surge Protected Strip Connectors
- AC Power Meters
- Relocatable AC Power Taps
- GFCI (Ground Fault Current Interrupter)
- UPS (Uninterruptable Power Supply)
- White Goods
- Plug-in TVSS
- Inverters
- AC/DC Power Supplies

Features

- RoHS compliant and Lead-free available
- Patented integrated thermal protection device - Patent #US6636403
- Designed to facilitate compliance to UL1449 2nd Edition for TVSS product
- High peak surge current rating up to 10kA
- Wave solderable
- Standard lead form and spacing option
- Low leakage
- -55°C to +85°C operating temp range
- Three-lead version available for indication purposes

Absolute Maximum Ratings

• For ratings of individual members of a series, see Device Ratings and Specifications chart

Continuous	TMOV® and iTMOV® Series	Units
Steady State Applied Voltage:		
AC Voltage Range ($V_{M(A)C(R)M(S)}$)	115 to 750	V
Transient:		
Peak Pulse Current (I_{TM})		
For 8x20 μ s Current Wave, single pulse	6,000 to 10,000	A
Single-Pulse Energy Capability		
For 2ms Current Wave	35 to 480	J
Operating Ambient Temperature Range (T_A)	-55 to +85	°C
Storage Temperature Range (T_{STG})	-55 to +125	°C
Temperature Coefficient (αV) of Clamping Voltage (V_C) at Specified Test Current	<0.01	%/°C
Hi-Pot Encapsulation (COATING Isolation Voltage Capability)	2,500	V
Thermal Protection Isolation Voltage Capability (when operated)	600	V
COATING Insulation Resistance	1,000	M Ω
Indicator Lead Rating (Lead-3 - iTMOV® varistor only):		
Continuous RMS current	100	mA
Surge Current, 8/20 μ s	10,000	A

CAUTION: Stresses above those listed in "Absolute Maximum Ratings" may cause permanent damage to the device. This is a stress only rating and operation of the device at these or any other conditions above those indicated in the operational sections of this specification is not implied.

TMOV® Ratings & Specifications

Lead-free and RoHS Compliant Models		Standard Models		Disc Dia-Meter	Maximum Rating (85°C)						Specifications (25 °C)				
					Continuous		Transient				Varistor Voltage at 1mA Test Current		Maximum Clamping Voltage 8/20 μ s		Typical Capacitance $f=1$ MHz
					AC Volts	Suppressed Voltage Rating	Energy 2ms	Peak Surge Current 8/20 μ s							
Part Number	Branding	Part Number	Branding	(mm)	$V_{M(A)C(R)M(S)}$ (V)	UL 1449 Table 60.1 (V)	W_{TM} (J)	$I_{TM} 1 \times$ Pulse (A)	$I_{TM} 2 \times$ Pulse (A)	$V_{N(D)C} Min$ (V)	$V_{N(D)C} Max$ (V)	V_C (V)	I_{PK} (A)	C (pF)	
TMOV14RP115E	P4T115E	TMOV14R115E	4T115E	14	115	300	35	6000	4500	162	198	300	50	1100	
TMOV20RP115E	P2T115E	TMOV20R115E	20T115E	20	115	300	52	10000	6500	162	198	300	100	2400	
TMOV14RP130E	P4T130E	TMOV14R130E	4T130E	14	130	400	50	6000	4500	184	226	340	50	1000	
TMOV20RP130E	P2T130E	TMOV20R130E	20T130E	20	130	400	100	10000	6500	184	226	340	100	1900	
TMOV14RP140E	P4T140E	TMOV14R140E	4T140E	14	140	500	55	6000	4500	200	240	360	50	900	
TMOV20RP140E	P2T140E	TMOV20R140E	20T140E	20	140	400	110	10000	6500	200	240	360	100	1750	
TMOV14RP150E	P4T150E	TMOV14R150E	4T150E	14	150	500	60	6000	4500	216	264	395	50	800	
TMOV20RP150E	P2T150E	TMOV20R150E	20T150E	20	150	400	120	10000	6500	216	264	395	100	1600	
TMOV14RP175E	P4T175E	TMOV14R175E	4T175E	14	175	700	70	6000	4500	243	297	455	50	700	
TMOV20RP175E	P2T175E	TMOV20R175E	20T175E	20	175	700	135	10000	6500	243	297	455	100	1400	
TMOV14RP200E	P4T200E	TMOV14R200E	4T200E	14	200	700	75	6000	4500	281	344	530	50	630	
TMOV20RP200E	P2T200E	TMOV20R200E	20T200E	20	200	700	154	10000	6500	281	344	530	100	1250	
TMOV14RP230E	P4T230E	TMOV14R230E	4T230E	14	230	700	80	6000	4500	324	396	595	50	550	
TMOV20RP230E	P2T230E	TMOV20R230E	20T230E	20	230	700	160	10000	6500	324	396	595	100	1100	
TMOV14RP250E	P4T250E	TMOV14R250E	4T250E	14	250	800	100	6000	4500	351	429	650	50	500	
TMOV20RP250E	P2T250E	TMOV20R250E	20T250E	20	250	700	170	10000	6500	351	429	650	100	1000	
TMOV14RP275E	P4T275E	TMOV14R275E	4T275E	14	275	900	110	6000	4500	387	473	710	50	450	
TMOV20RP275E	P2T275E	TMOV20R275E	20T275E	20	275	700	190	10000	6500	387	473	710	100	900	
TMOV14RP300E	P4T300E	TMOV14R300E	4T300E	14	300	900	125	6000	4500	423	517	775	50	400	
TMOV20RP300E	P2T300E	TMOV20R300E	20T300E	20	300	900	250	10000	6500	423	517	775	100	800	
TMOV14RP320E	P4T320E	TMOV14R320E	4T320E	14	320	900	136	6000	4500	459	561	840	50	380	
TMOV20RP320E	P2T320E	TMOV20R320E	20T320E	20	320	900	372	10000	6500	459	561	840	100	750	
TMOV14RP385E	P4T385E	TMOV14R385E	4T385E	14	385	1200	150	6000	4500	558	682	1025	50	360	
TMOV20RP385E	P2T385E	TMOV20R385E	20T385E	20	385	1200	300	10000	6500	558	682	1025	100	700	
TMOV14RP420E	P4T420E	TMOV14R420E	4T420E	14	420	1200	160	6000	4500	612	748	1120	50	300	
TMOV20RP420E	P2T420E	TMOV20R420E	20T420E	20	420	1200	320	10000	6500	612	748	1120	100	600	
TMOV20RP460E	P2T460E	TMOV20R460E	20T460E	20	460	n/a	360	10000	6500	675	825	1240	100	200	

TMOV® Ratings & Specifications (Continued...)

Lead-free and RoHS Compliant Models		Standard Models		Disc Diameter	Maximum Rating (85°C)					Specifications (25°C)				
					AC Volts	Suppressed Voltage Rating	Energy 2ms	Peak Surge Current 8/20µs		Varistor Voltage at 1mA Test Current	Maximum Clamping Voltage 8/20µs	Typical Capacitance f = 1MHz		
V _{MIA/CIRMS}	UL 1449 Table 60.1	W _{TM}	I _{TM} 1 x Pulse					I _{TM} 2 x Pulse	V _{N(DC)} Min				V _{N(DC)} Max	V _C
Part Number	Branding	Part Number	Branding	(mm)	(V)	(V)	(J)	(A)	(A)	(V)	(V)	(A)	(pF)	
TMOV20RP510E	P2T510E	TMOV20R510E	20T510E	20	510	n/a	325	10000	6500	738	902	1355	100	350
TMOV20RP550E	P2T550E	TMOV20R550E	20T550E	20	550	n/a	360	10000	6500	819	1001	1500	100	300
TMOV20RP575E	P2T575E	TMOV20R575E	20T575E	20	575	n/a	375	10000	6500	856	1047	1568	100	275
TMOV20RP625E	P2T625E	TMOV20R625E	20T625E	20	625	n/a	400	10000	6500	900	1100	1650	100	250
TMOV20RP750E	P2T750E	TMOV20R750E	20T750E	20	750	n/a	480	10000	6500	1080	1320	1980	100	175

NOTE: For 14mm devices with a voltage rating greater than 420V, please contact factory regarding availability.

iTMOV® Ratings & Specifications

Lead-free And RoHS Compliant Models		Standard Models		Disc Diameter	Maximum Rating (85°C)					Specifications (25°C)				
					AC Volts	Suppressed Voltage Rating	Energy 2ms	Peak Surge Current 8/20µs		Varistor Voltage at 1mA Test Current	Maximum Clamping Voltage 8/20µs	Typical Capacitance f = 1MHz		
V _{MIA/CIRMS}	UL 1449 Table 60.1	W _{TM}	I _{TM} 1 x Pulse					I _{TM} 2 x Pulse	V _{N(DC)} Min				V _{N(DC)} Max	V _C
Part Number	Branding	Part Number	Branding	(mm)	(V)	(V)	(J)	(A)	(A)	(V)	(V)	(A)	(pF)	
TMOV14RP115M	P4T115M	TMOV14R115M	4T115M	14	115	300	35	6000	4500	162	198	300	50	1100
TMOV20RP115M	P2T115M	TMOV20R115M	20T115M	20	115	300	52	10000	6500	162	198	300	100	2400
TMOV14RP130M	P4T130M	TMOV14R130M	4T130M	14	130	400	50	6000	4500	184	226	340	50	1000
TMOV20RP130M	P2T130M	TMOV20R130M	20T130M	20	130	400	100	10000	6500	184	226	340	100	1900
TMOV14RP140M	P4T140M	TMOV14R140M	4T140M	14	140	500	55	6000	4500	200	240	360	50	900
TMOV20RP140M	P2T140M	TMOV20R140M	20T140M	20	140	400	110	10000	6500	200	240	360	100	1750
TMOV14RP150M	P4T150M	TMOV14R150M	4T150M	14	150	500	60	6000	4500	216	264	395	50	800
TMOV20RP150M	P2T150M	TMOV20R150M	20T150M	20	150	400	120	10000	6500	216	264	395	100	1600
TMOV14RP175M	P4T175M	TMOV14R175M	4T175M	14	175	700	70	6000	4500	243	297	455	50	700
TMOV20RP175M	P2T175M	TMOV20R175M	20T175M	20	175	700	135	10000	6500	243	297	455	100	1400
TMOV14RP200M	P4T200M	TMOV14R200M	4T200M	14	200	700	75	6000	4500	281	344	530	50	630
TMOV20RP200M	P2T200M	TMOV20R200M	20T200M	20	200	700	154	10000	6500	281	344	530	100	1250
TMOV14RP230M	P4T230M	TMOV14R230M	4T230M	14	230	700	80	6000	4500	324	396	595	50	550
TMOV20RP230M	P2T230M	TMOV20R230M	20T230M	20	230	700	160	10000	6500	324	396	595	100	1100
TMOV14RP250M	P4T250M	TMOV14R250M	4T250M	14	250	800	100	6000	4500	351	429	650	50	500
TMOV20RP250M	P2T250M	TMOV20R250M	20T250M	20	250	700	170	10000	6500	351	429	650	100	1000
TMOV14RP275M	P4T275M	TMOV14R275M	4T275M	14	275	900	110	6000	4500	387	473	710	50	450
TMOV20RP275M	P2T275M	TMOV20R275M	20T275M	20	275	700	190	10000	6500	387	473	710	100	900
TMOV14RP300M	P4T300M	TMOV14R300M	4T300M	14	300	900	125	6000	4500	423	517	775	50	400
TMOV20RP300M	P2T300M	TMOV20R300M	20T300M	20	300	900	250	10000	6500	423	517	775	100	800
TMOV14RP320M	P4T320M	TMOV14R320M	4T320M	14	320	900	136	6000	4500	459	561	840	50	380
TMOV20RP320M	P2T320M	TMOV20R320M	20T320M	20	320	900	372	10000	6500	459	561	840	100	750
TMOV14RP385M	P4T385M	TMOV14R385M	4T385M	14	385	1200	150	6000	4500	558	682	1025	50	360
TMOV20RP385M	P2T385M	TMOV20R385M	20T385M	20	385	1200	300	10000	6500	558	682	1025	100	700
TMOV14RP420M	P4T420M	TMOV14R420M	4T420M	14	420	1200	160	6000	4500	612	748	1120	50	300
TMOV20RP420M	P2T420M	TMOV20R420M	20T420M	20	420	1200	320	10000	6500	612	748	1120	100	600
TMOV20RP460M	P2T460M	TMOV20R460M	20T460M	20	460	n/a	360	10000	6500	675	825	1240	100	200
TMOV20RP510M	P2T510M	TMOV20R510M	20T510M	20	510	n/a	325	10000	6500	738	902	1355	100	350
TMOV20RP550M	P2T550M	TMOV20R550M	20T550M	20	550	n/a	360	10000	6500	819	1001	1500	100	300
TMOV20RP575M	P2T575M	TMOV20R575M	20T575M	20	575	n/a	375	10000	6500	856	1047	1568	100	275
TMOV20RP625M	P2T625M	TMOV20R625M	20T625M	20	625	n/a	400	10000	6500	900	1100	1650	100	250
TMOV20RP750M	P2T750M	TMOV20R750M	20T750M	20	750	n/a	480	10000	6500	1080	1320	1980	100	175

NOTE: For 14mm devices with a voltage rating greater than 420V, please contact factory regarding availability.

Thermal Characteristics

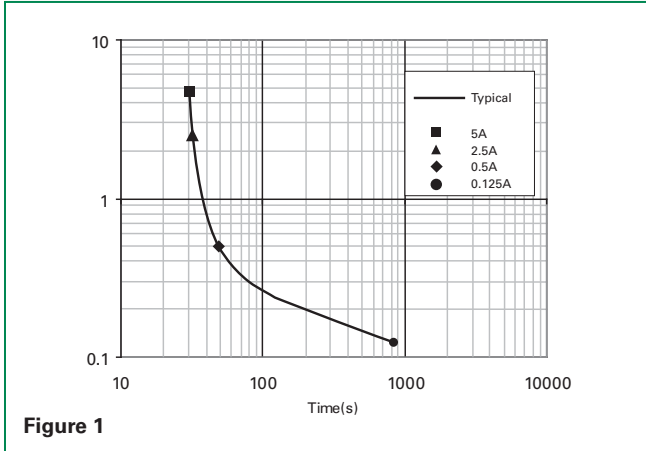

Figure 1

Note : The TMOV® and iTMOV® varistors are intended, in conjunction with appropriate enclosure design, to help facilitate TVSS module compliance to UL 1449, 2nd Edition Section 37.4 (abnormal overvoltage limited current requirements). Under these extreme abnormal overvoltage conditions, some units will exhibit substantial heating, arcing and venting prior to opening. Modules should be designed to contain this possibility. Application testing is strongly recommended.

Current, Energy, Power Derating Curve

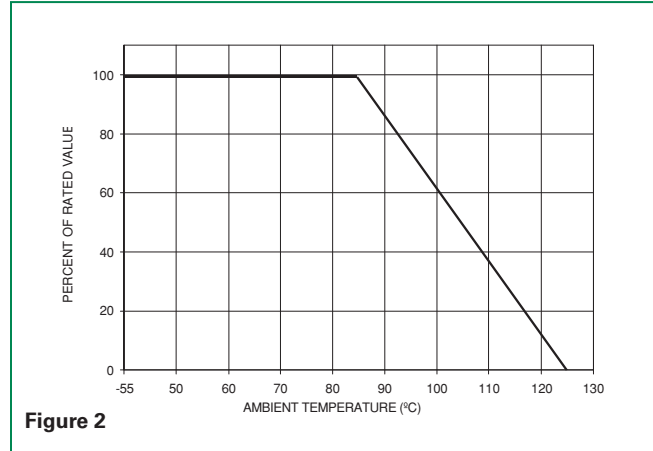

Figure 2

For applications exceeding 85°C ambient temperature, the peak surge current and energy ratings must be reduced as shown above.

Maximum Clamping Voltage for 14mm Parts

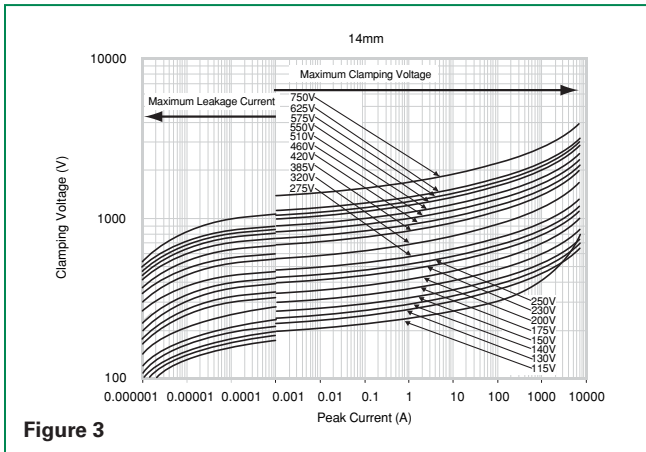

Figure 3

Maximum Clamping Voltage for 20mm Parts

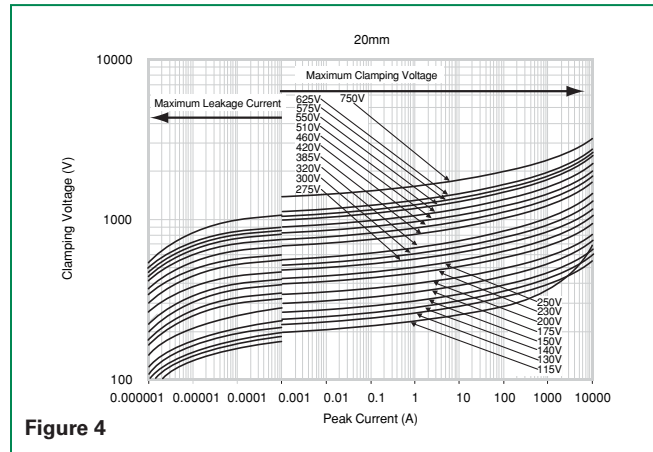

Figure 4

Repetitive Surge Capability for 14mm Parts

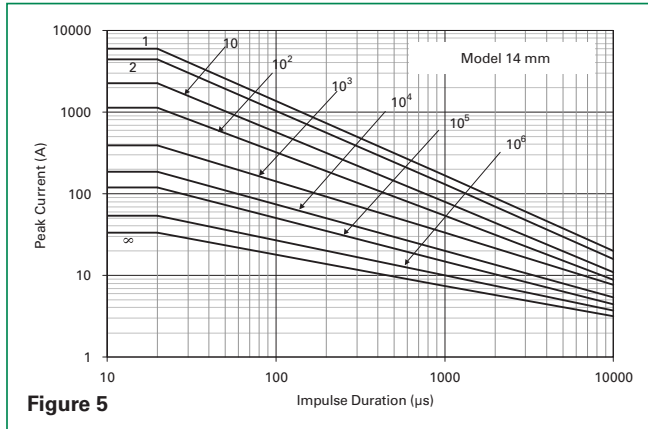

Figure 5

NOTE: Average power dissipation of transients should not exceed 0.6W

Repetitive Surge Capability for 20mm Parts

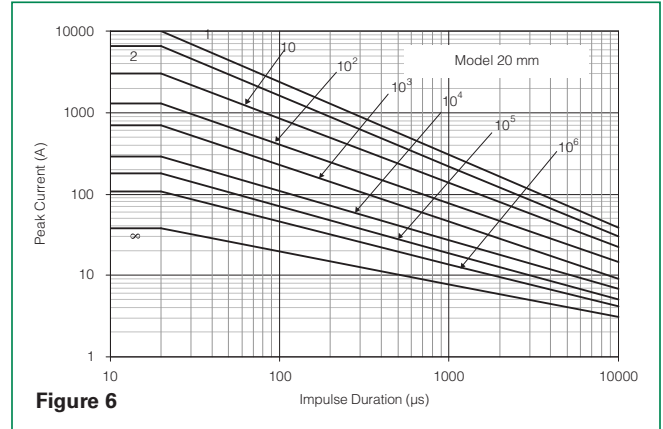

Figure 6

NOTE: Average power dissipation of transients should not exceed 1.0W

Wave Solder Profile

Because the TMOV® and iTMOV® varistors contain a thermal protection device, care must be taken when soldering the devices into place. Two soldering methods are possible. Firstly, hand soldering: It is recommended to heat-sink the leads of the device. Secondly, wave soldering: It is critically important that all preheat stage and the solder bath temperatures are rigidly controlled.

Non Lead-free Profile

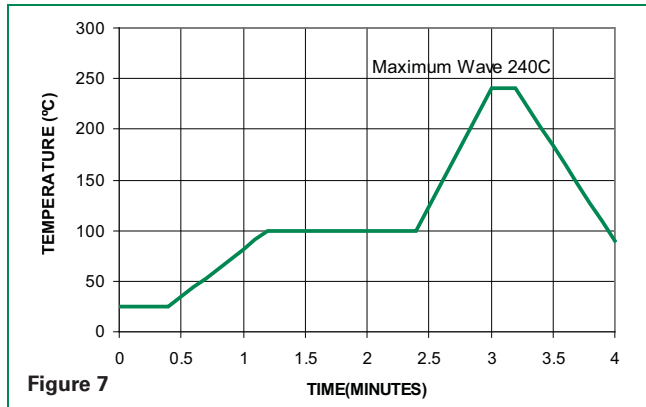

Figure 7

Lead-free Profile

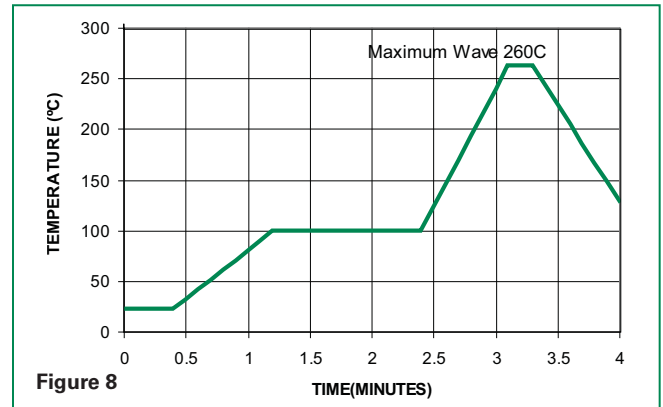

Figure 8

Physical Specifications

Lead Material	Non Lead-free parts: Solder coated Copper wire, or Tin-coated Copper wire Lead-free parts: Tin-coated Copper wire
Soldering Characteristics	Solderability per MIL-STD-202, Method 208E
Insulating Material	Cured, flame retardant epoxy polymer meets UL94V-0 requirements
Device Labeling	Marked with LF, voltage, UL/CSA logos, and date code

Environmental Specifications

Operating/Storage Temperature	-40°C to +85°C
Passive Aging	+85°C, 1000 hours +/-10% typical voltage change
Humidity Aging	+85°C, 85% RH, 1000 hours +/-10% typical voltage change
Thermal Shock	+85°C to -40°C 5 times +/-10% typical voltage change
Solvent Resistance	MIL-STD-202, Method 215F
Moisture Sensitivity	Level 1, J-STD-020C

TMOV®/iTMOV® Series

Lead Configurations

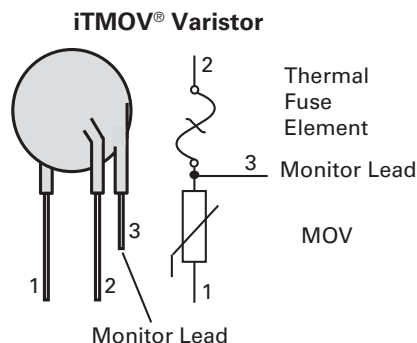
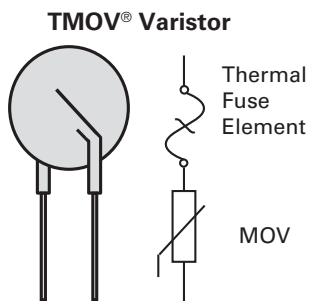

Note: MOVs are non-polarized passive elements

iTMOV® Varistor Application Examples

The application examples below show how the indicator lead on the iTMOV® can be used to indicate that the thermal element has been opened. This signifies that the circuit is no longer protected from transients by the MOV.

Application Example 1

In this case, the LED is normally on, and is off when the thermal element opens.

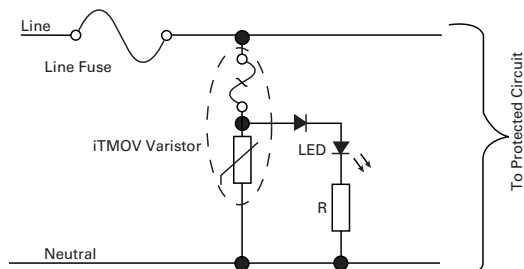

Application Example 2

This circuit utilizes an optocoupler to provide galvanic isolations between the iTMOV® varistor and the indicating or alarm circuitry.

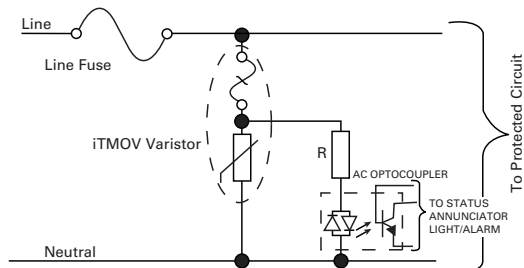

Application Example 3

This circuit illustrates the use of the monitoring lead of the iTMOV® varistor to ensure that equipment is only operated when overvoltage protection is present. In normal operation the load switch relay solenoid is powered via the indicator lead of the iTMOV® varistor. In the event of the thermal element being activated, the relay will de-activate, cutting power to the protected circuit and the fault LED will illuminate.

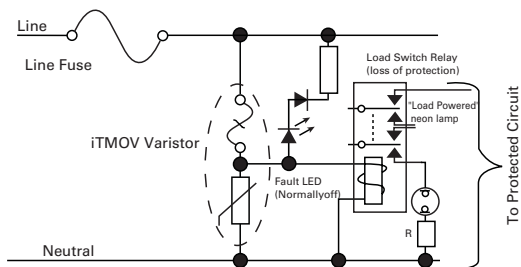

Please note: Indicator circuits are provided as a guideline only. Verification of actual indicator circuitry is the responsibility of the end user. Component values selected must be appropriate for the specific AC line voltage service and application.

Device Dimensions

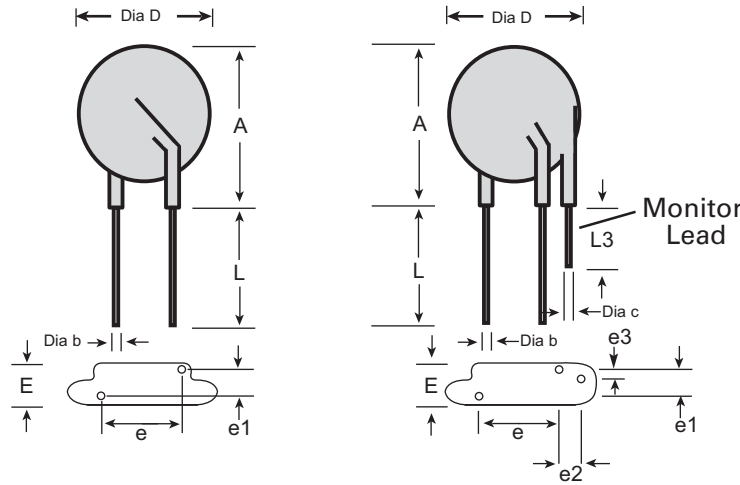

Dimension	V _{RMS} Voltage Model	TMOV® Varistor				iTMOV® Varistor			
		14mm Size		20mm Size		14mm Size		20mm Size	
		Min. mm (in)	Max. mm (in)	Min. mm (in)	Max. mm (in)	Min. mm (in)	Max. mm (in)	Min. mm (in)	Max. mm (in)
A	ALL	17.0 (0.669)	22.0 (0.866)	23.0 (0.906)	28.0 (1.10)	17.0 (0.669)	22.0 (0.866)	23.0 (0.906)	28.0 (1.10)
Dia D	ALL	13.5 (0.531)	17.0 (0.669)	19.0 (0.748)	23.0 (0.906)	13.5 (0.531)	17.0 (0.669)	19.0 (0.748)	23.0 (0.906)
e	ALL	6.5 (0.256)	8.5 (0.335)	6.5 (0.256)	8.5 (0.335)	6.5 (0.256)	8.5 (0.335)	6.5 (0.256)	8.5 (0.335)
e1 Bulk Pack	115-175	1.5 (0.059)	4.0 (0.157)	1.5 (0.059)	4.0 (0.157)	1.5 (0.059)	4.0 (0.157)	1.5 (0.059)	4.0 (0.157)
	200-420	2.0 (0.079)	6.0 (0.236)	2.0 (0.079)	6.0 (0.236)	2.0 (0.079)	6.0 (0.236)	2.0 (0.079)	6.0 (0.236)
	460-750	n/a	n/a	0	2.0 (0.079)	n/a	n/a	0	2.0 (0.079)
e1 Tape & Reel	115-420	0	2.0 (0.079)	0	2.0 (0.079)	0	2.0 (0.079)	0	2.0 (0.079)
	460-550*	n/a	n/a	0	2.0 (0.079)	n/a	n/a	0	2.0 (0.079)
e2	ALL	n/a	n/a	n/a	n/a	4.0 (0.138)	6.0 (0.236)	4.0 (0.157)	6.0 (0.236)
e3	ALL	n/a	n/a	n/a	n/a	0	2.0 (0.079)	0	2.0 (0.079)
E	115-175	--	9.0 (0.335)	--	9.0 (0.335)	--	9.0 (0.335)	--	9.0 (0.335)
	200-275	--	9.5 (0.374)	--	9.5 (0.374)	--	9.5 (0.374)	--	9.5 (0.374)
	300-460	--	11.0 (0.433)	--	11.0 (0.433)	--	11.0 (0.433)	--	11.0 (0.433)
	510-575	--	n/a	--	12.0 (0.472)	--	n/a	--	12.0 (0.472)
	625-750	--	n/a	--	13.0 (0.512)	--	n/a	--	13.0 (0.512)
L	ALL	25.4 (1.00)	--	25.4 (1.00)	--	25.4 (1.00)	--	25.4 (1.00)	--
L3	ALL	n/a	n/a	n/a	n/a	6.0 (0.236)	--	6.0 (0.236)	--
Dia b	115-420	0.76 (0.030)	0.86 (0.034)	0.76 (0.030)	0.86 (0.034)	0.76 (0.030)	0.86 (0.034)	0.76 (0.030)	0.86 (0.034)
	460-750	n/a	n/a	0.95 (0.037)	1.05 (0.041)	n/a	n/a	0.95 (0.037)	1.05 (0.041)
Dia c Outside Lead Only	ALL	n/a	n/a	n/a	n/a	0.76 (0.030)	0.86 (0.034)	0.76 (0.030)	0.86 (0.034)

NOTES:

For 14mm ratings above 420 V_{RMS} contact factory for specifications.

* Items above 550 V_{RMS} are not available packaged as tape and reel (bulk pack only)

TMOV®/iTMOV® Series

Tape and Reel Specification

TMOV® VARISTOR WITH OUTER CRIMP

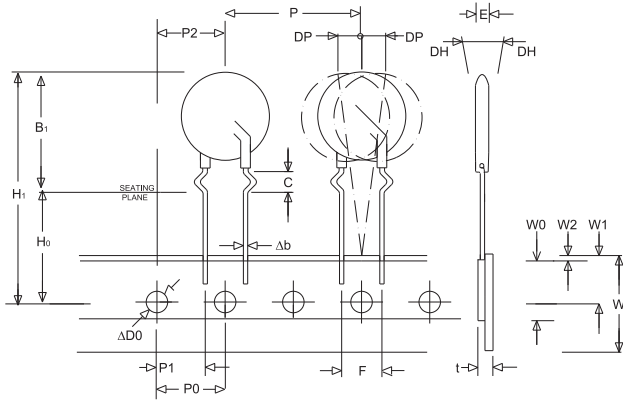

iTMOV® VARISTOR WITH INNER CRIMP

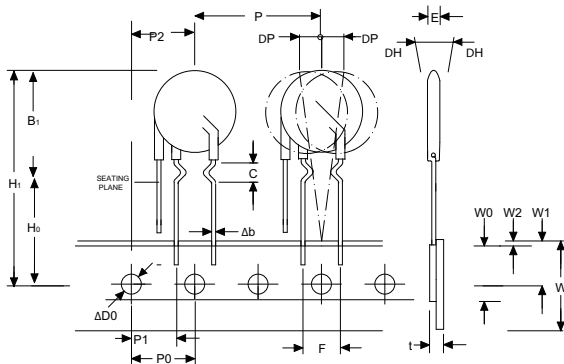

- Reel capacity varies with voltage.
- Leads are crimped and in-line. This excludes the monitor lead on iTMOV® devices which are not crimped and not in-line.
- To order tape and reel option please add suffix 'L2T7' to end of standard part number.
- Tape and reel option is available for rated voltages up to 420V. Contact factory regarding availability of higher voltages.

Contact Littelfuse for additional details.

	DESCRIPTION	MODEL SIZE	
		14mm	20mm
B₁	Component Top to Seating Plane	22.5 Max	31 Max
P	Pitch of Component	25.4 +/- 1.0	25.4 +/- 1.0
P₀	Feed Hole Pitch	12.7 +/- 0.2	12.7 +/- 0.2
P₁	Feed Hole Center to Pitch	8.95 +/- 0.7	8.95 +/- 0.7
P₂	Hole Center to Component Center	12.7 +/- 0.7	12.7 +/- 0.7
F	Lead to Lead Distance	7.5 +/- 0.8	7.5 +/- 0.8
Δh	Component Alignment	2.0 Max	2.0 Max
W	Tape Width	18.0 +1.0/-0.5	18.0 +1.0/-0.5
W₀	Hold Down Tape Width	12.0 +/- 0.3	12.0 +/- 0.3
W₁	Hole Position	9.0 +0.75/-0.50	9.0 +0.75/-0.50
W₂	Hold Down Tape Position	0.5 Max	0.5 Max
H₁	Component Height	40.0 Max	46.5 Max
D₀	Feed Hole Diameter	4.0 +/- 0.2	4.0 +/- 0.2
t	Total Tape Thickness	0.7 +/- 0.2	0.7 +/- 0.2
L	Length of Clipped Lead	11.0 Max	11.0 Max
Δp	Component Alignment	3 Max. 1.00mm	3 Max
C	Crimp Length	2.6 typ	2.6 typ
H₀	Seating Plane Height	16.0 +/- 0.5	16.0 +/- 0.5

Dimensions in mm

Part Numbering System

Standard Parts

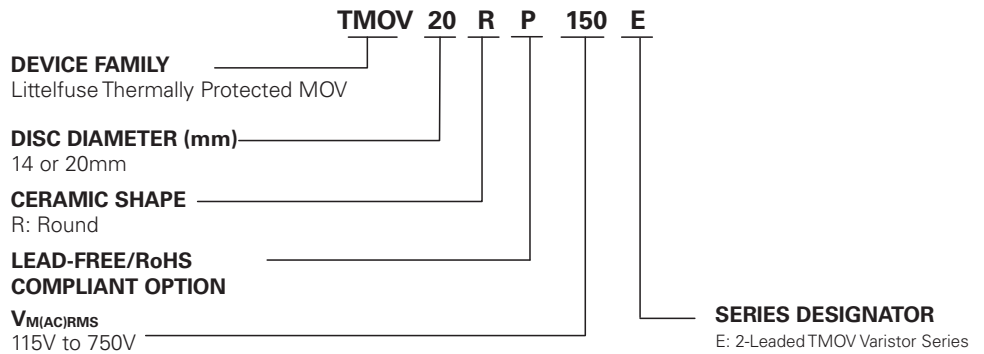

NOTE: By ordering the standard part number, i.e. TMOV20R150E or TMOV20RP150E, standard straight lead styles, standard bulk packing and standard lead spacing will be supplied. These specifications are as follows:

- Straight Leads
- Bulk Packed
- 7.5mm Lead Spacing
- Leads not in-line except parts > 420 V

Pack Quantities

Rated Voltage	Pack Quantities			
	Bulk Pack		Tape and Reel	
	Model Size		Model Size	
	14mm	20mm	14mm	20mm
115-250	600	400	500	400
275-550	500	300	400	300
575-750	400	200	n/a	n/a

NOTE: Tape and Reel available up to 420V only - please contact factory regarding availability of higher voltage parts.