

2J6602B

2.4/5.0 GHz ISM Screw Mount

Key Features

2.4/5.0 GHz ISM

- 2410-2490 MHz
- 4920-5925 MHz

Screw Mount

Low Profile

Anti-Rotation Mechanism

Ground Plane Independent

Customizable Cable and Connector

Dimensions $\varnothing 77.3 \times 15$ mm

Certificates: IP67, IP69K



1. Antenna and electrical specifications

Parameters	2.4/5.0 GHz ISM Antenna	
Standards	WiFi, BT, ZigBee, ISM	
Band (MHz)	2.4 GHz	5.0 GHz
Frequency (MHz)	2410-2490	4920-5925
Return Loss (dB)	~-14.3	~-14.2
VSWR	~1.5:1	~1.5:1
Efficiency (%)	~48.7	~29.2
Peak Gain (dBi)	~4.9	~4.5
Average Gain (dB)	~-3.1	~-5.4
Impedance (Ohm)	50	
Polarisation	Linear	
Radiation Pattern	Omni-Directional	
Max. Input Power (W)	25	
Connector Type	RP-SMA-Male Standard (Other Connectors Available)	
Cable Length	300 cm Standard (Any Cable Length Available)	
Cable Type	DACAR302 Standard (Other Cables Available)	

Antenna Measurement Conditions:

Mounted on Ground Plane of 30x30 cm

200 cm of DACAR302 Cable

Measured in Certified CTIA 3D Anechoic Chamber

2. Mechanical and environmental specifications

Specifications	2J6602B
Mounting Type	Screw Mount
Dimensions (mm)	Ø 77.3 × 15
Radome	ASA
Radome color	Black or White
Antenna Base	Zamak
Gasket	TPE
Operating Temperature (C)	-40 to +85
Storage Temperature (C)	-40 to +85
Substance Compliance	RoHS
Certificates	IP67, IP69K

3. Antenna parameters

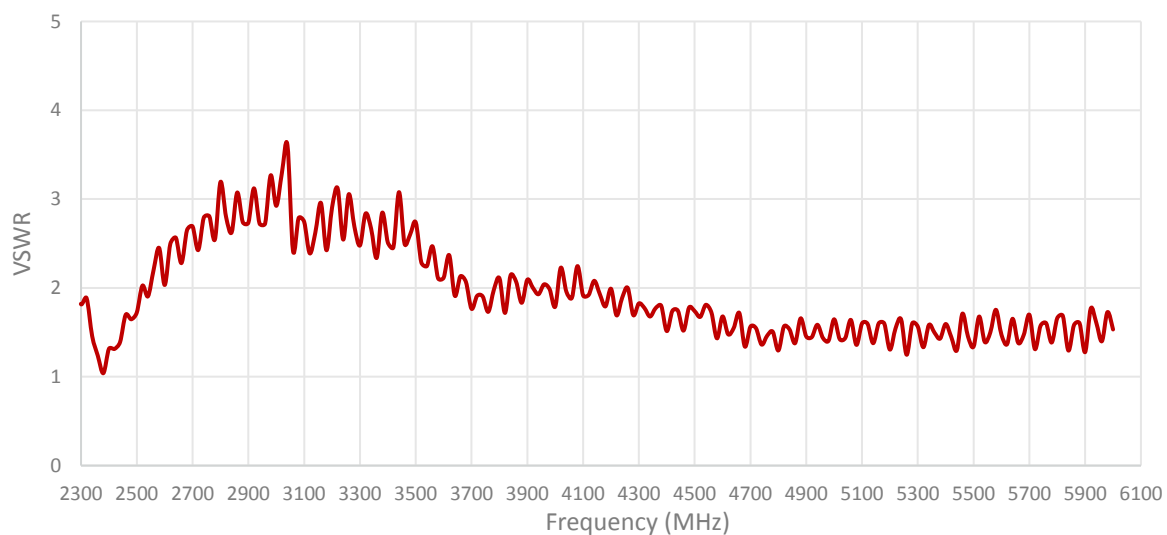
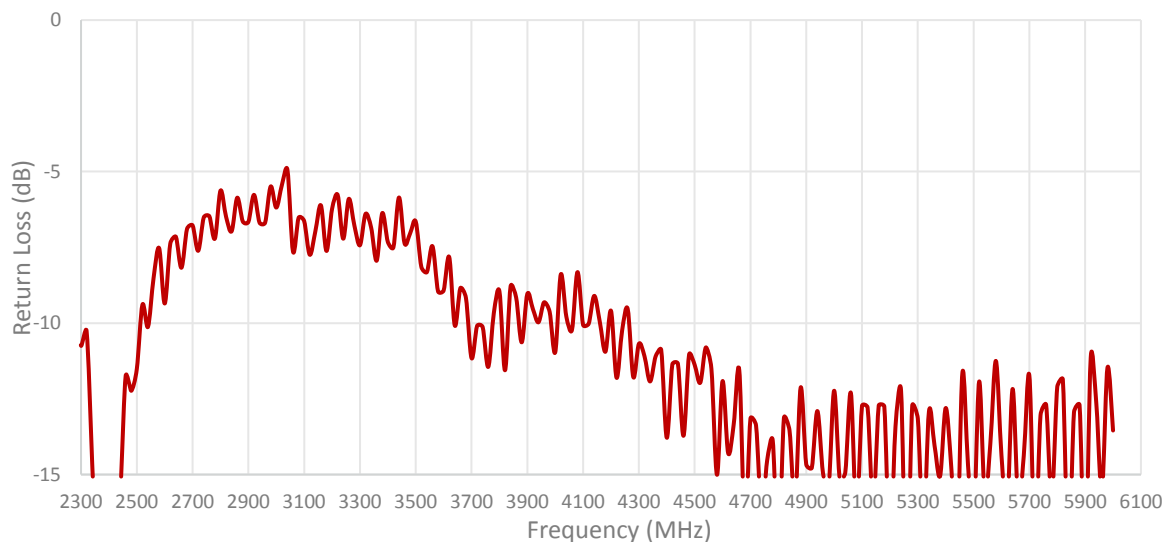

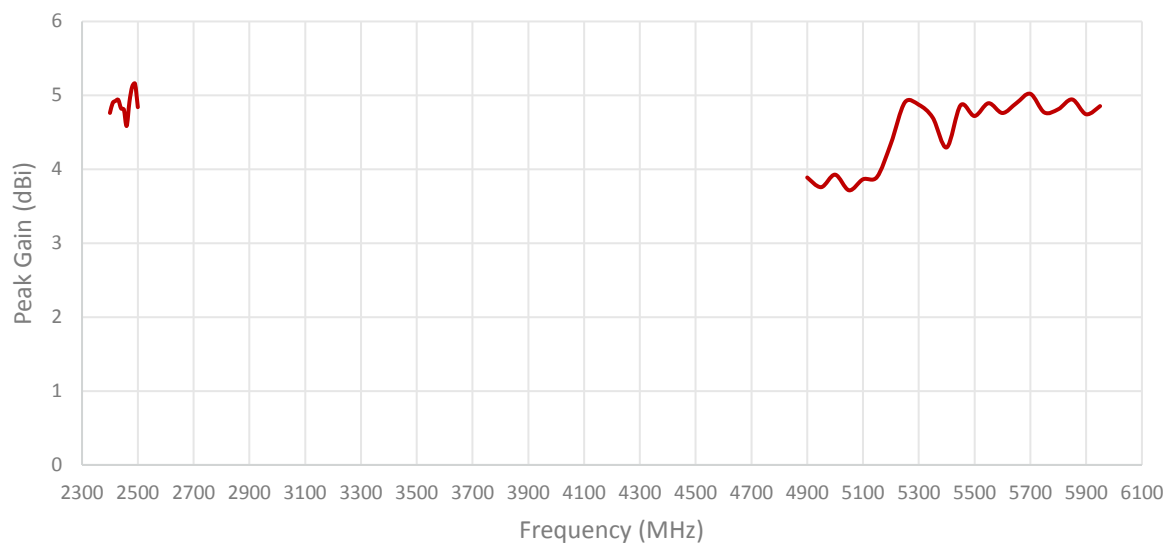
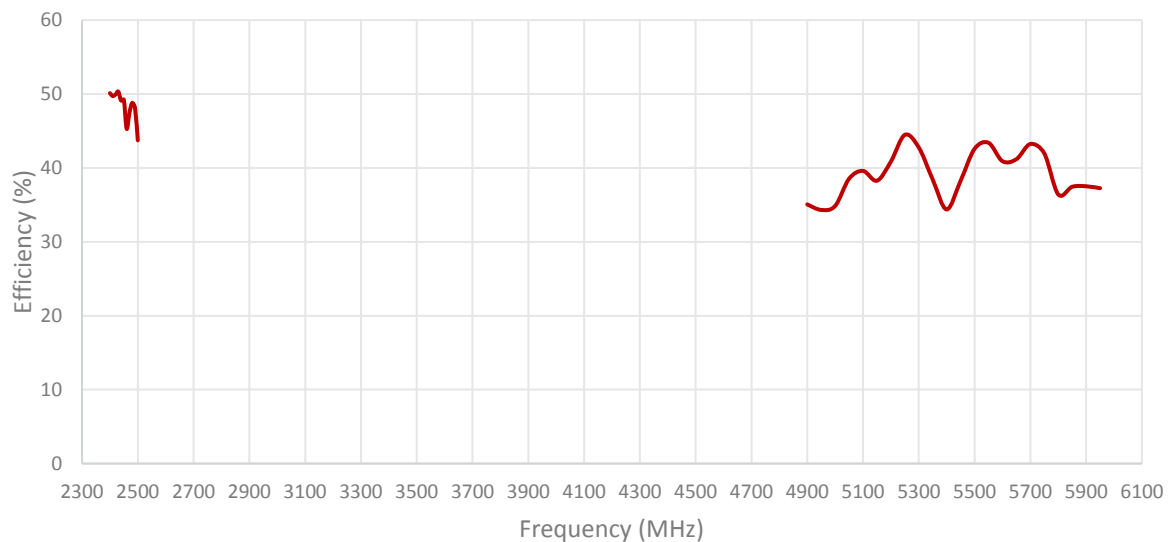

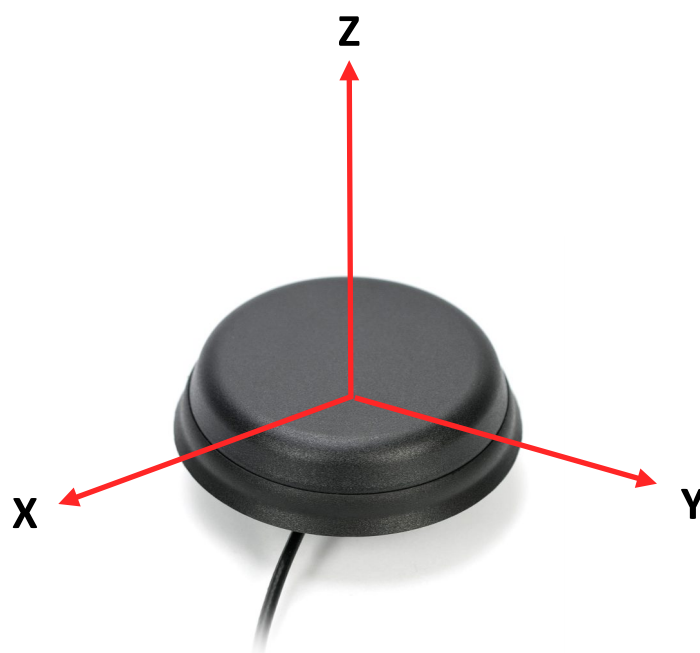
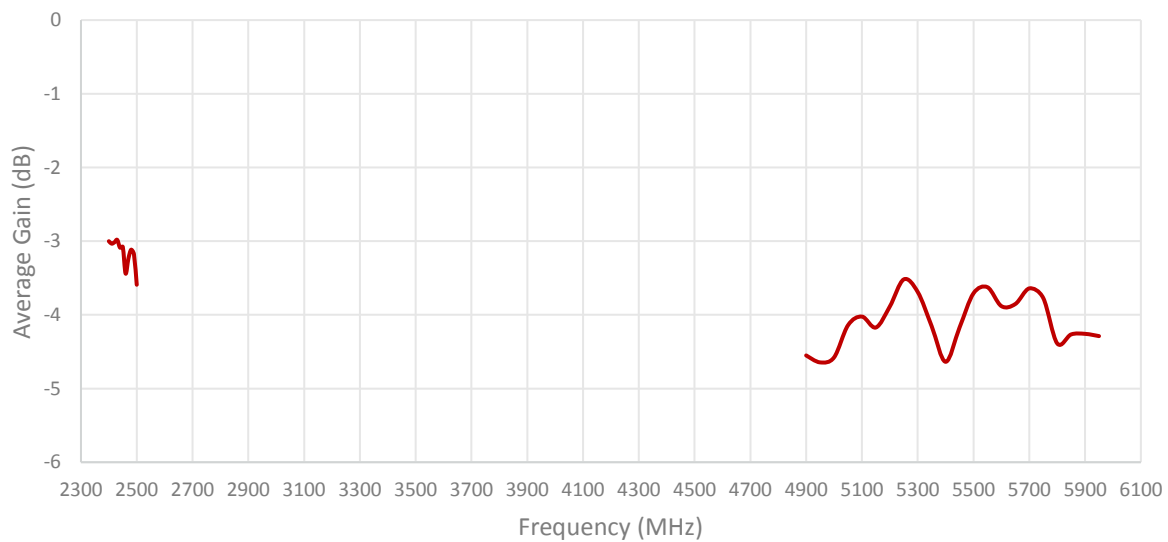

Radiation pattern reference

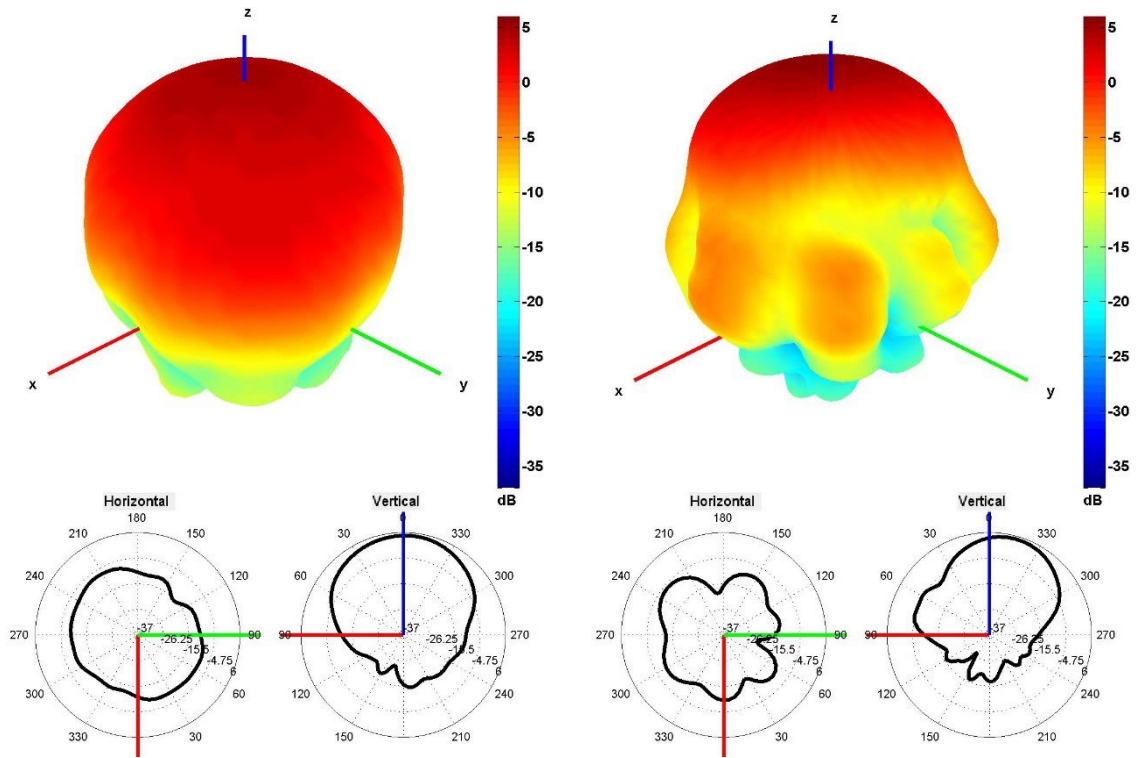

2450 and 5500 MHz Radiation pattern

4. Antenna drawings

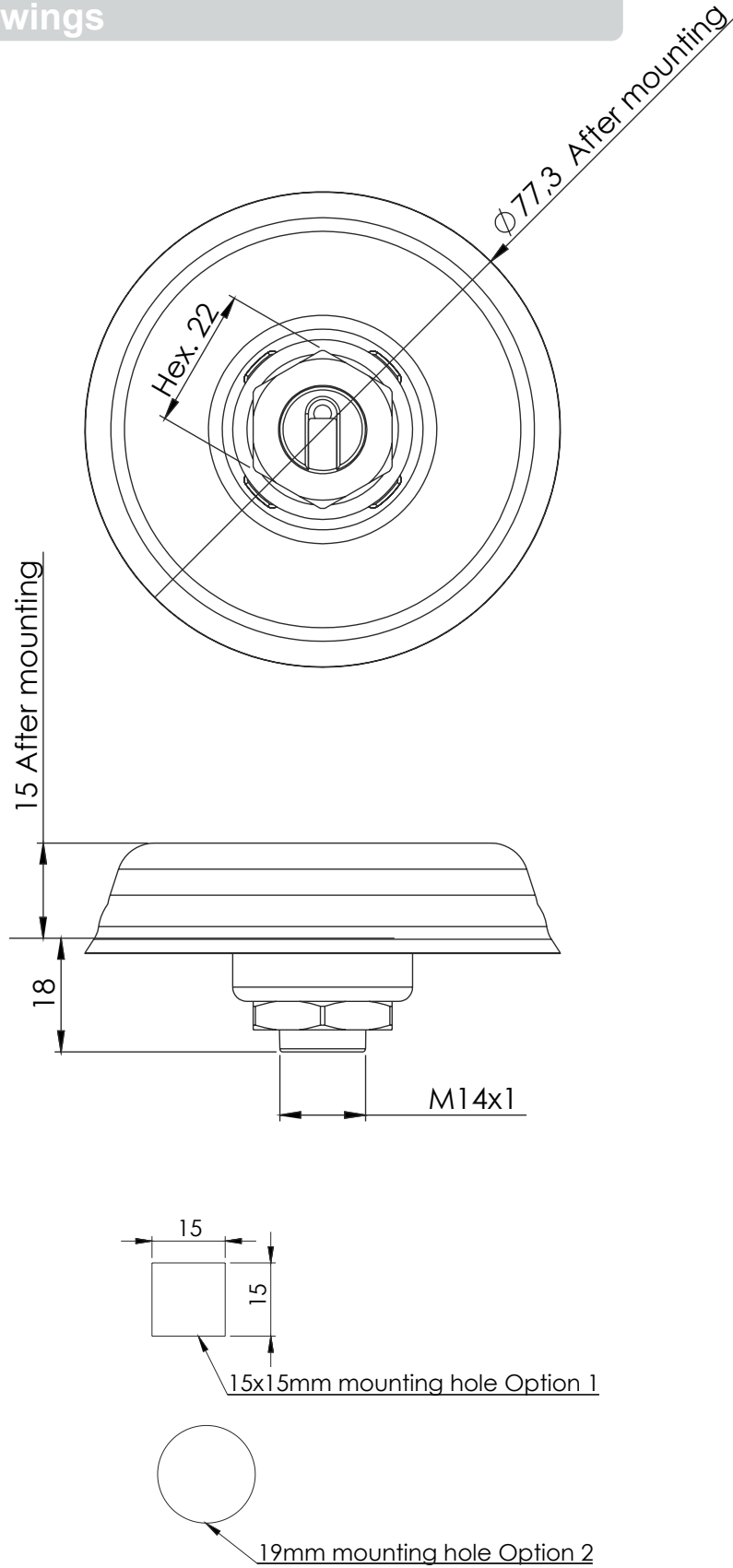

5. Antenna Images

